

**Starters**

**School**



A B C D E F G  
H I J K L M N  
O P Q R S T  
U V W X Y Z



**alphabet**

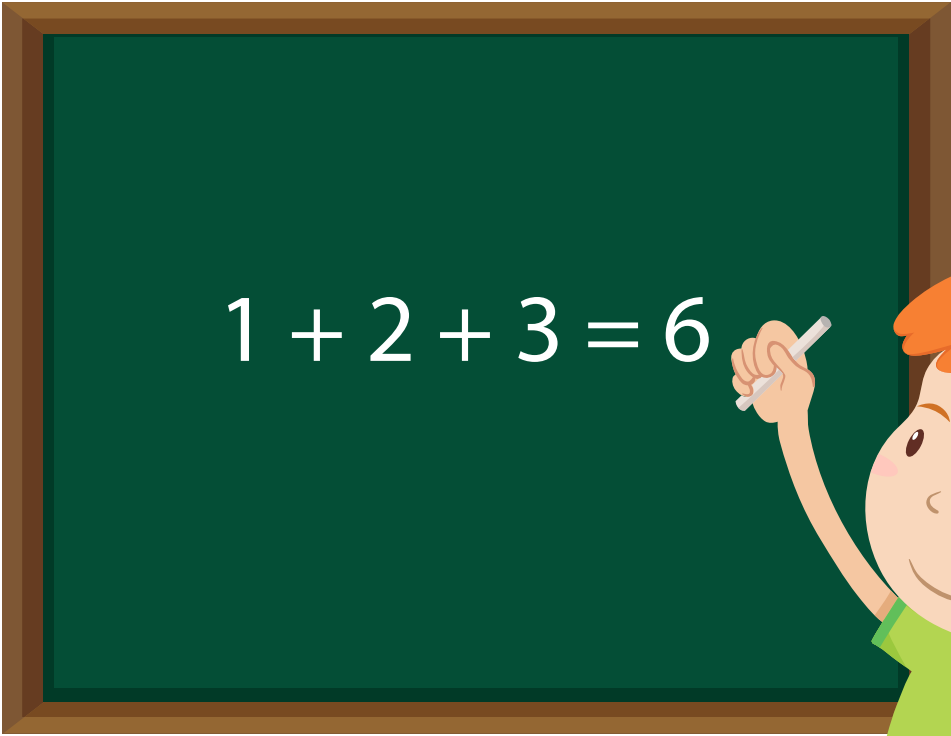

$$1 + 2 + 3 = 6$$



**answer**



**ask**



$$1 + 2 + 3 = 6$$



**board**





**books**



**bookcase**

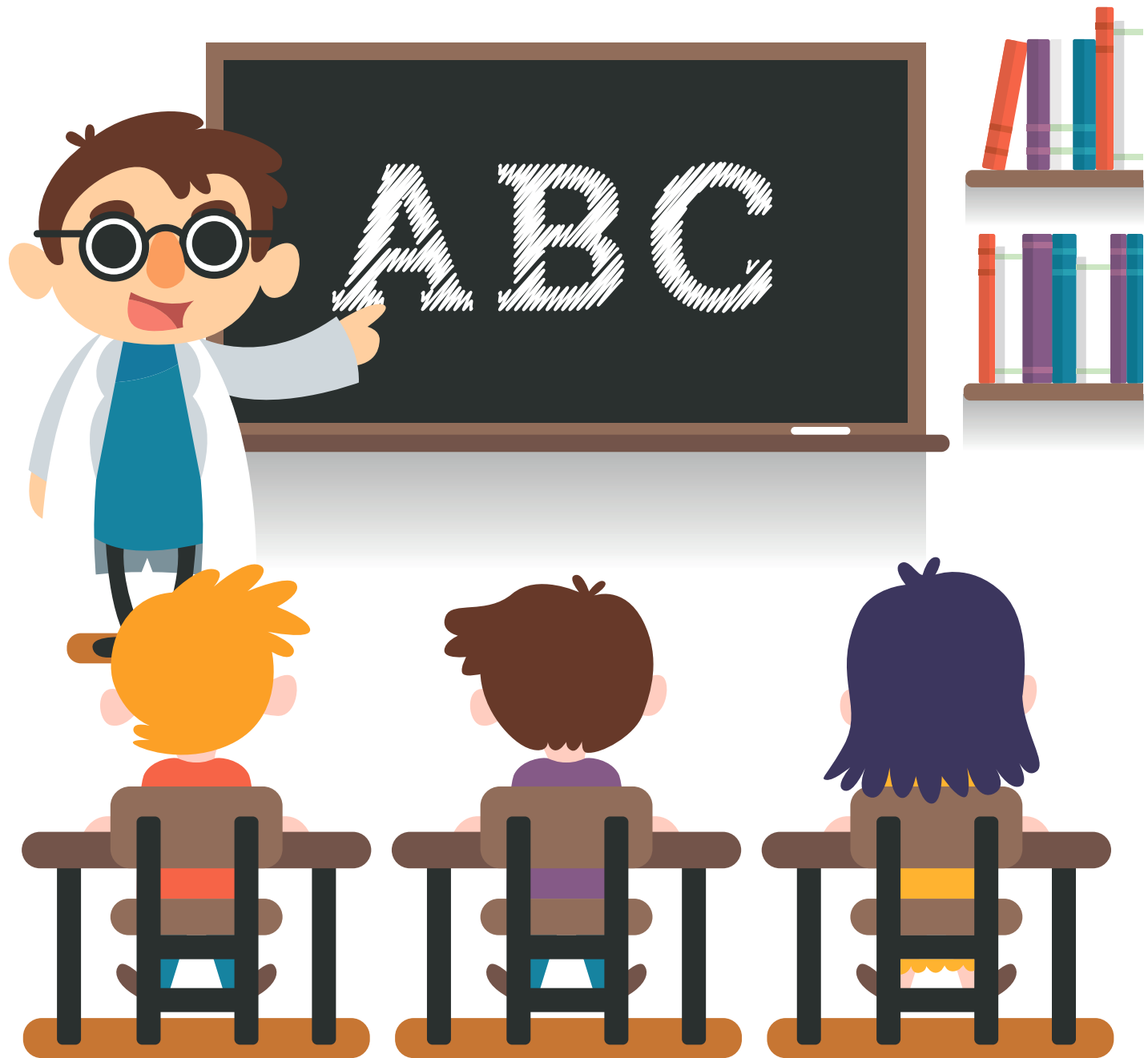



**class**



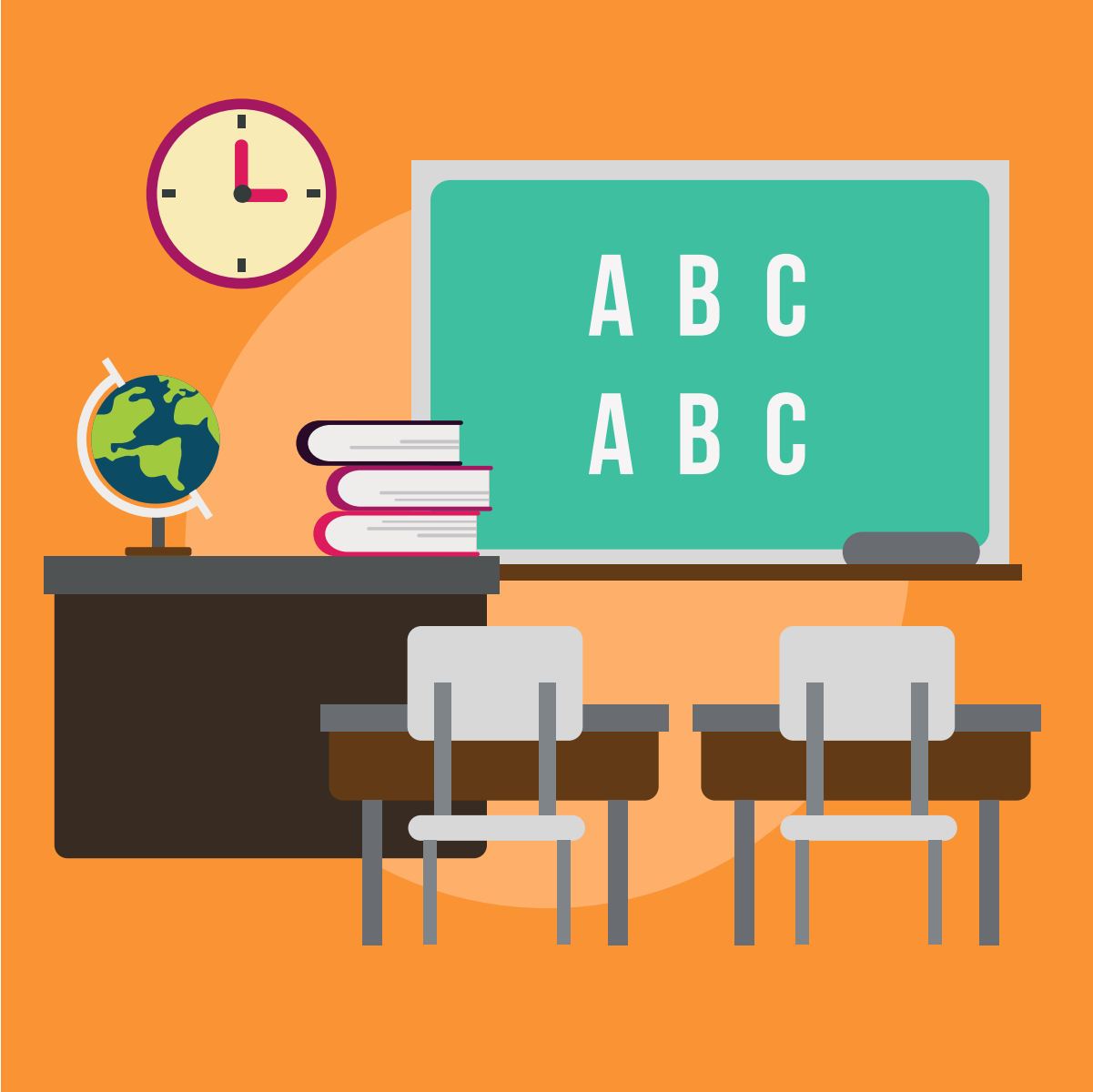



**classroom**





**close**

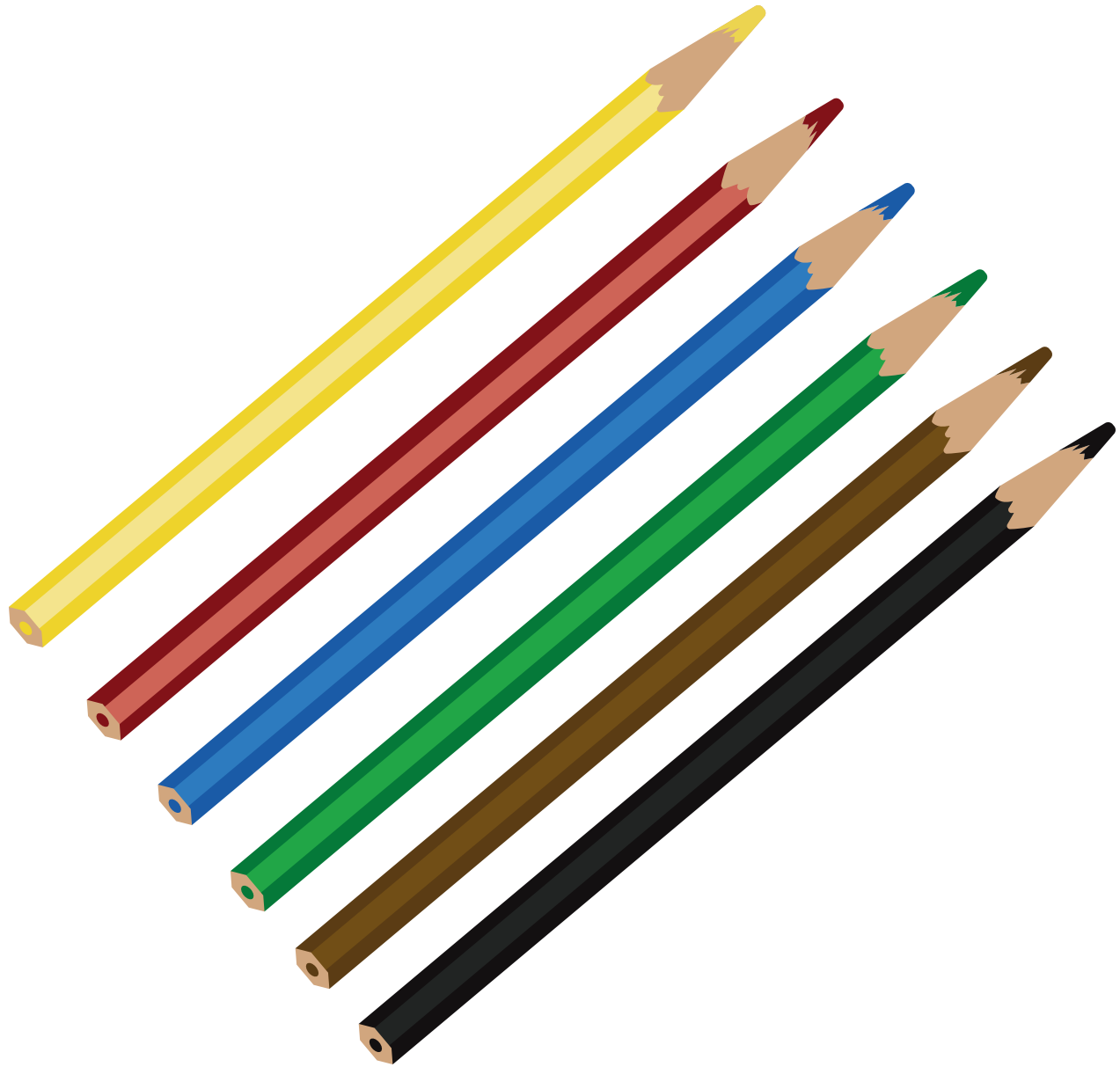



**colours**

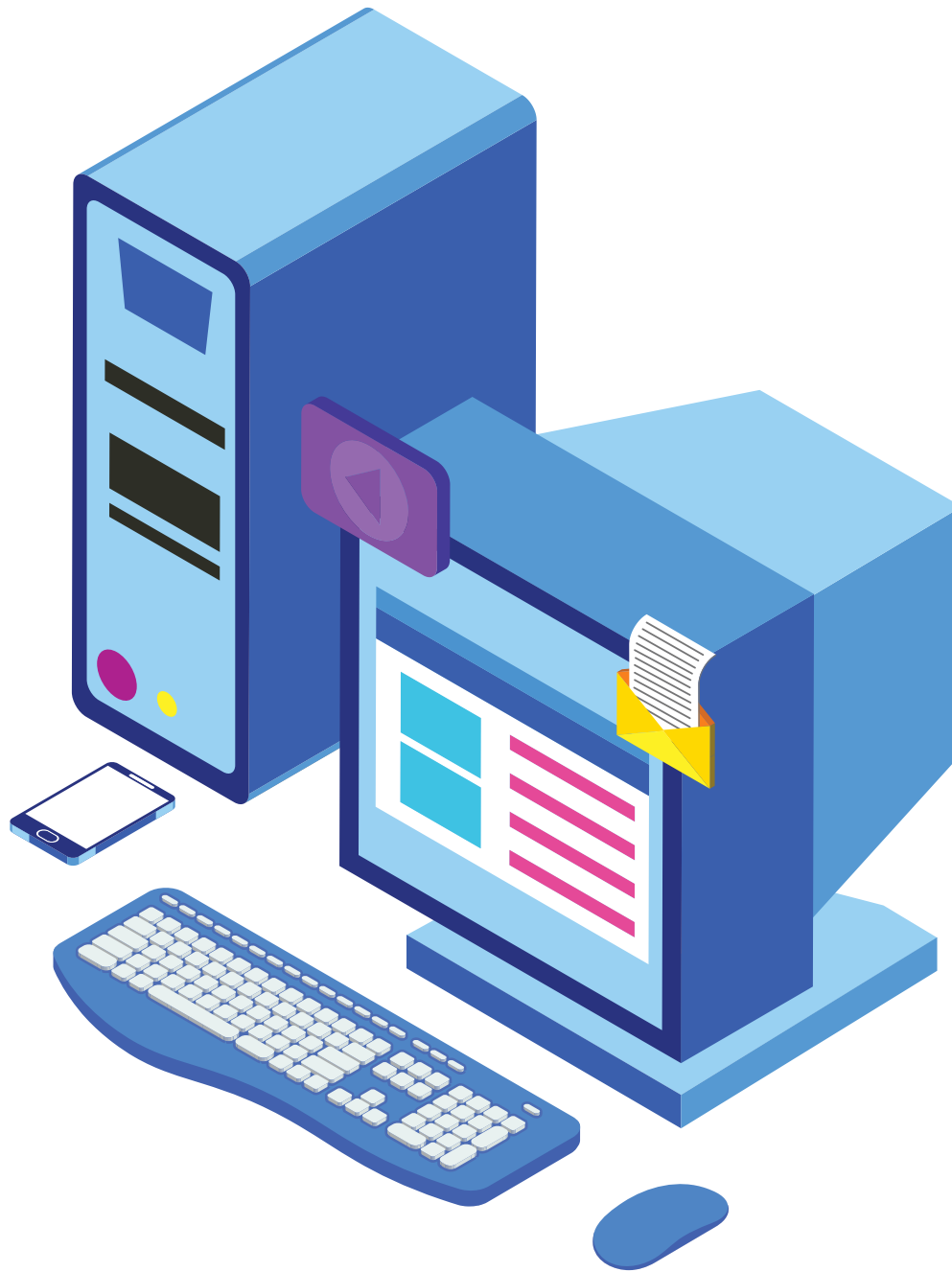

**computer**





**correct**



**cross**

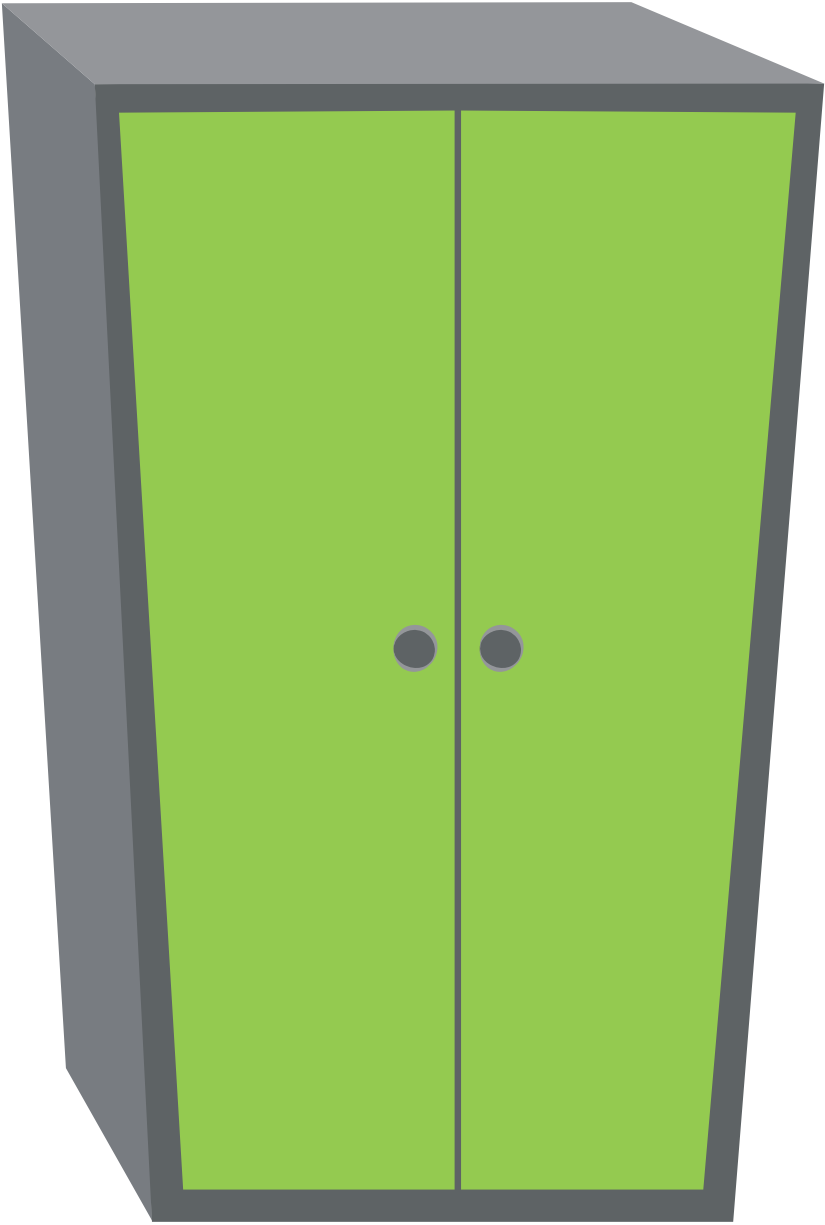

**cupboard**



**desk**





**door**



**draw**



**English**

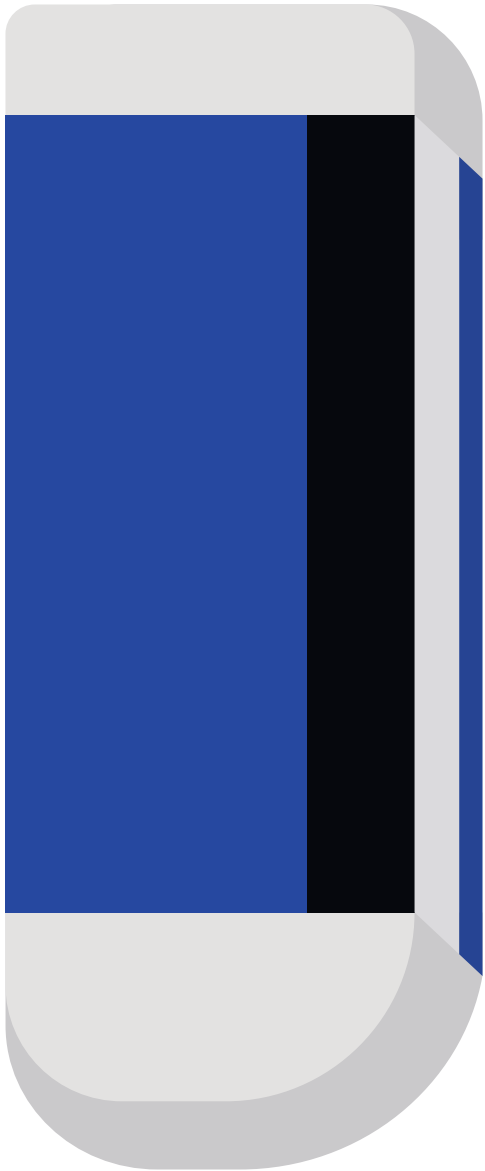

**eraser**



J



**example**



**find**

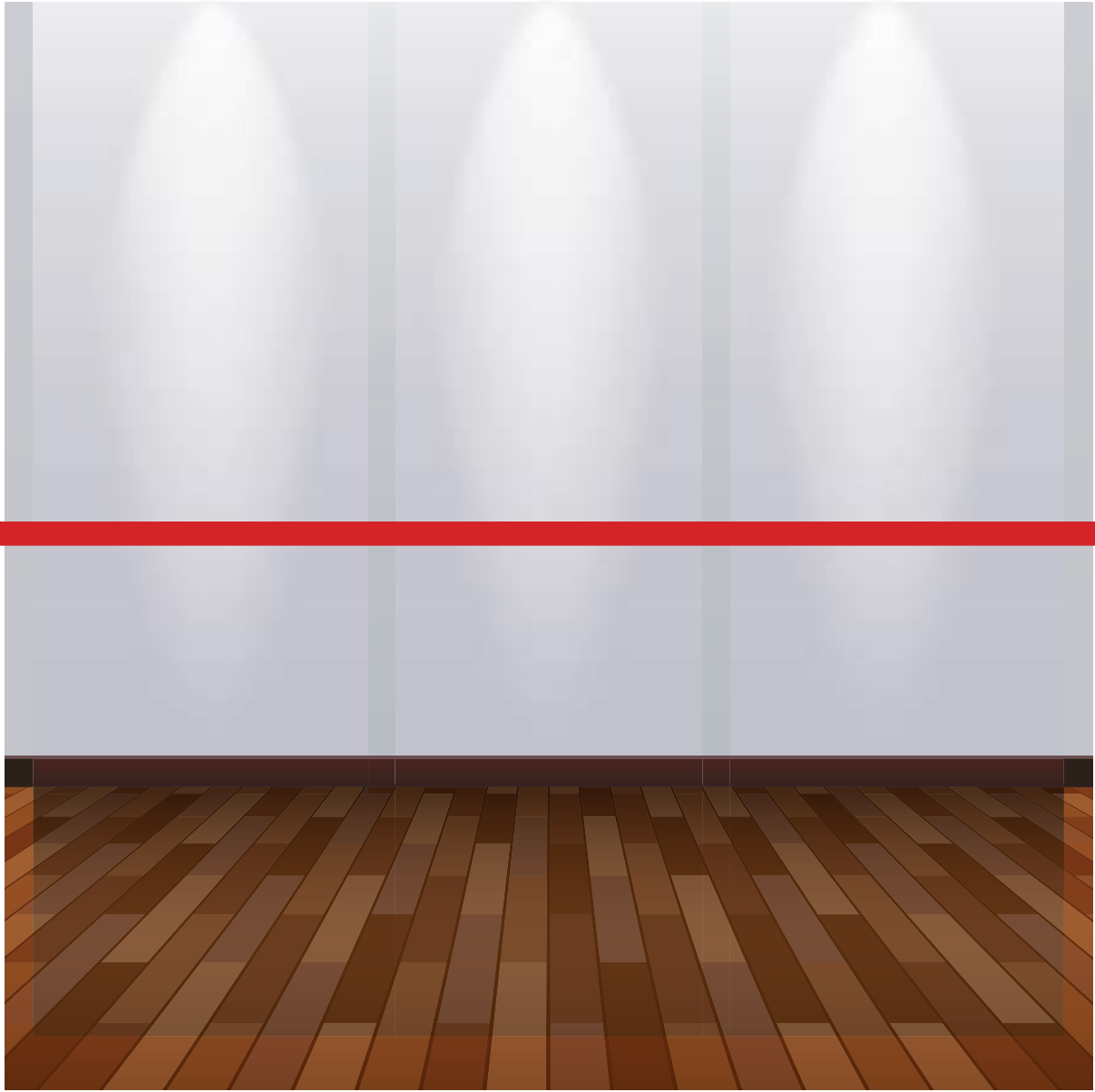

**floor**

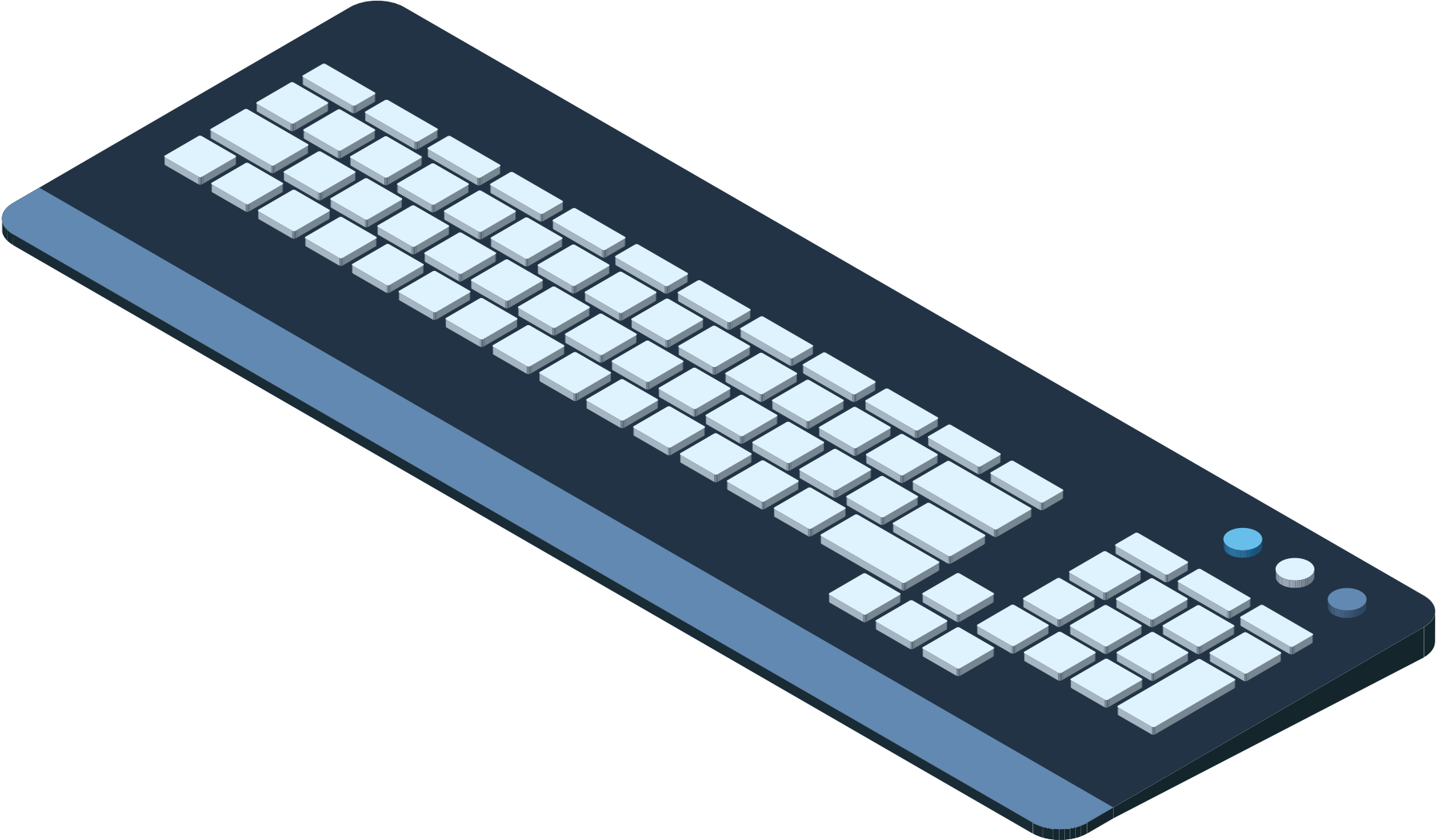

**keyboard**



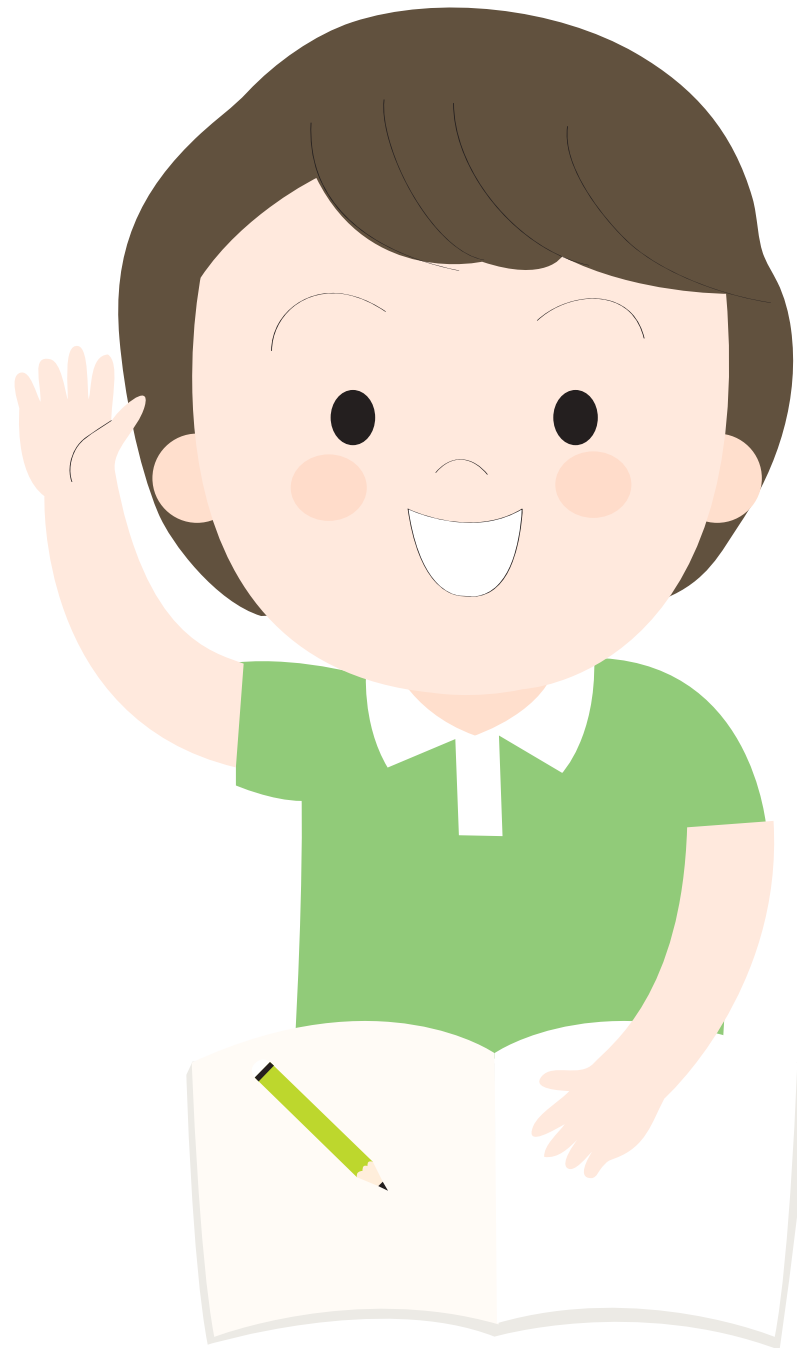

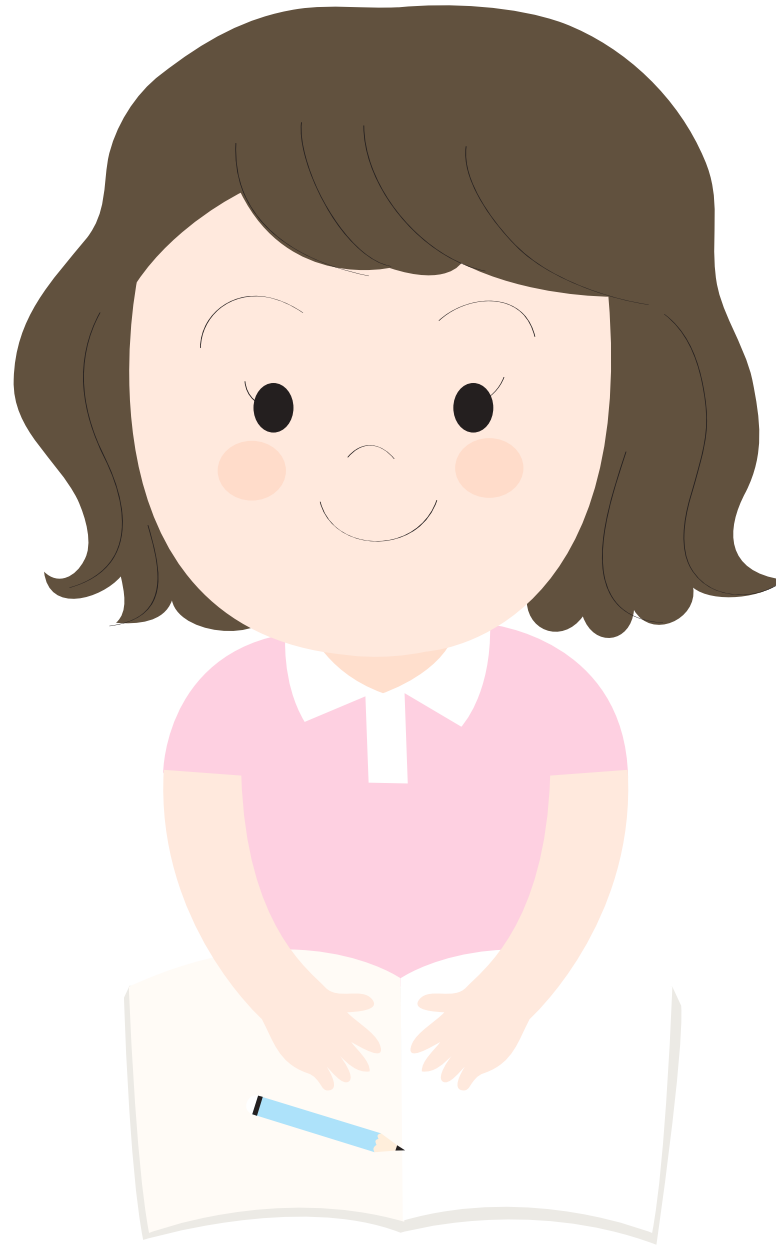

**know**



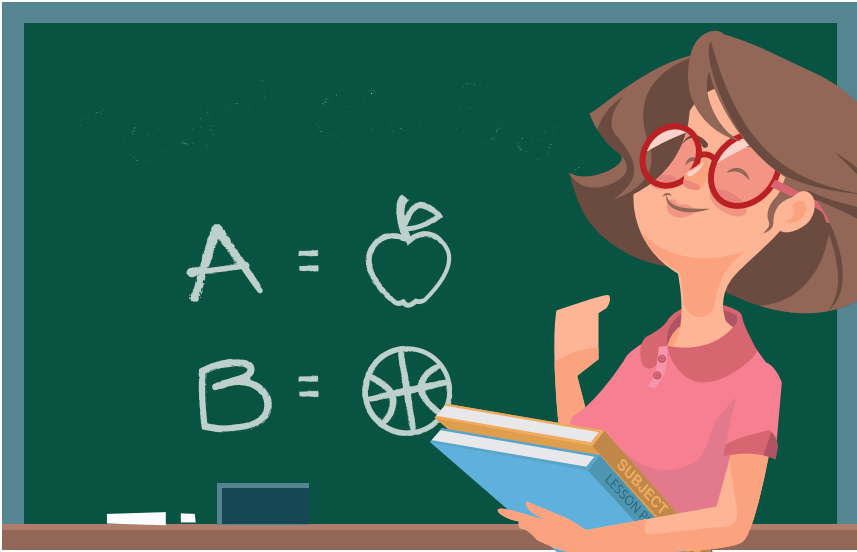

**learn**



A = 

B = 



**lesson**



**letter**



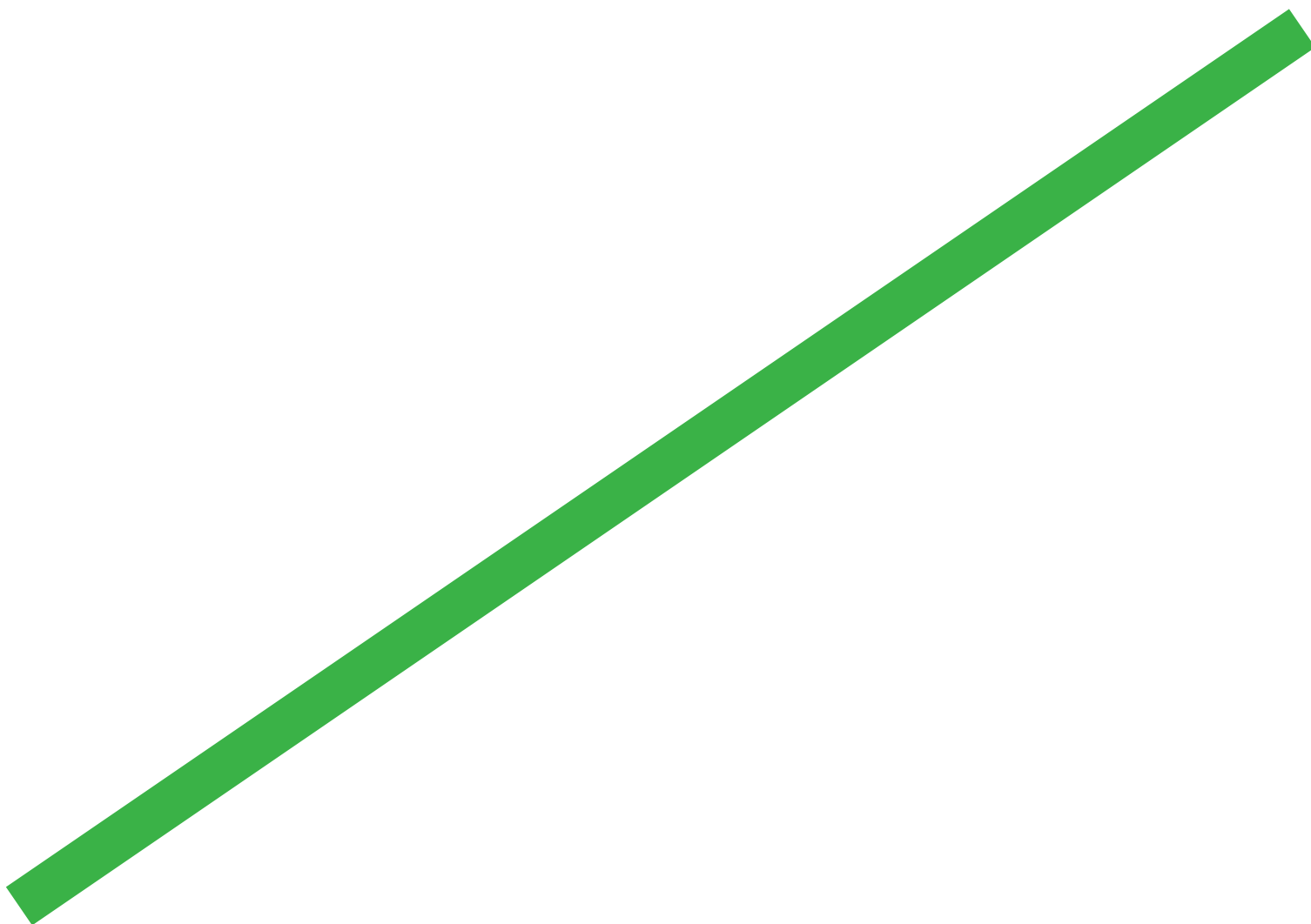

**line**



**listen**



**look**



**mouse**







**music**





**numbers**



**open**

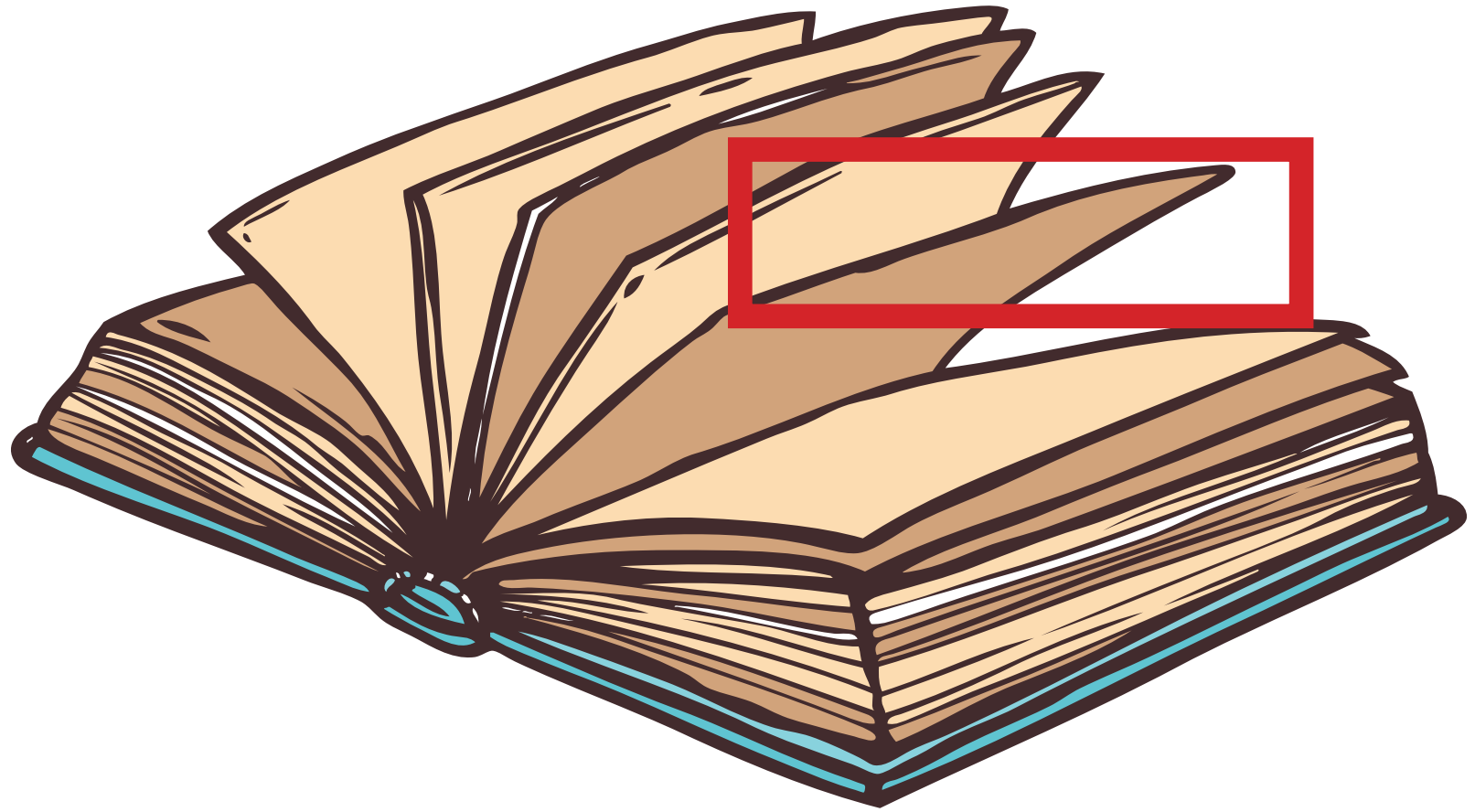



**page**



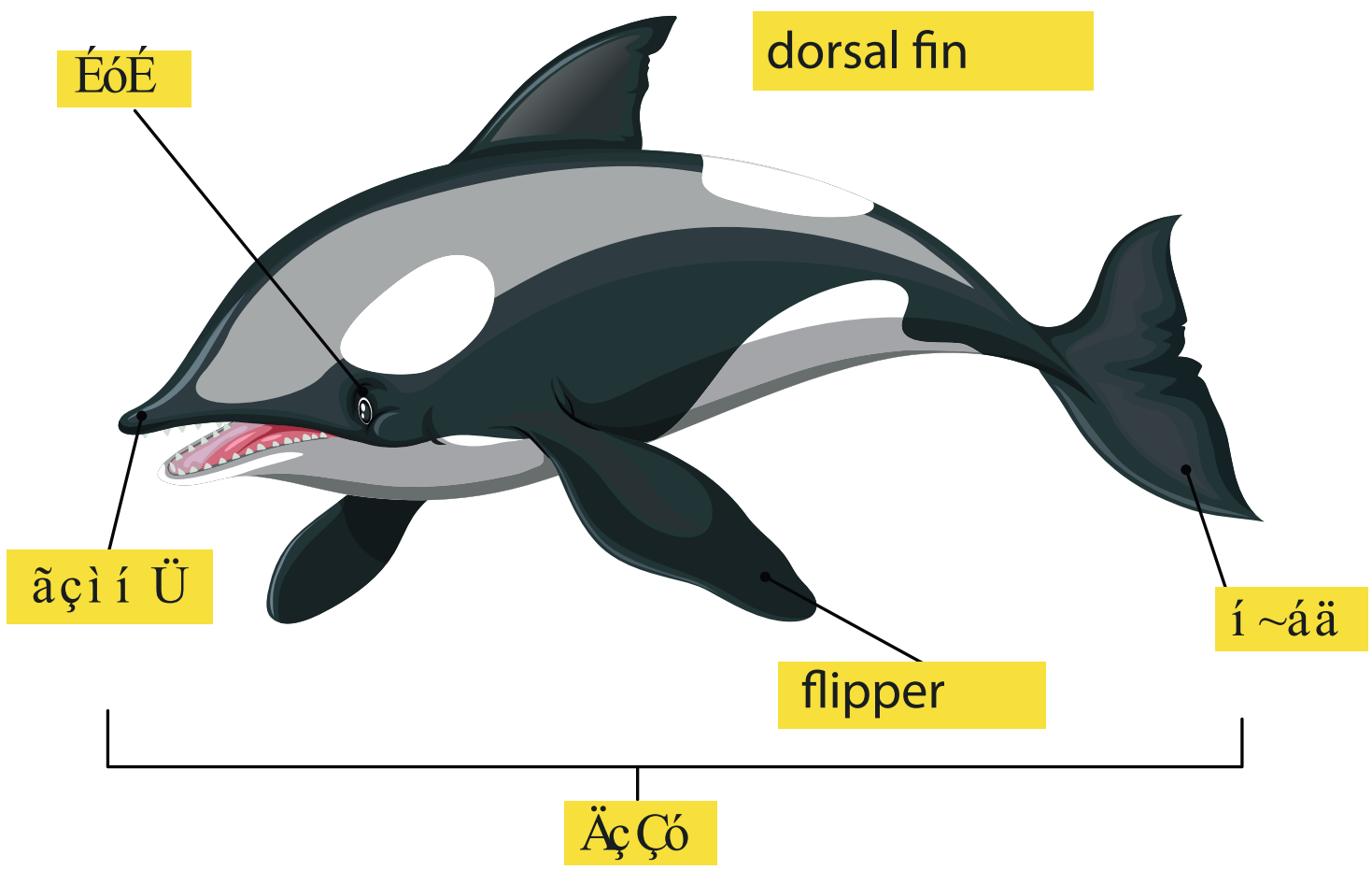

ÉóÉ

dorsal fin

ãçìí Ü

í ~áä

flipper

Äç Çó

**part**



**pen**



**pencil**





**picture**





**playground**





**question**



**read**



**right**





**rubber**

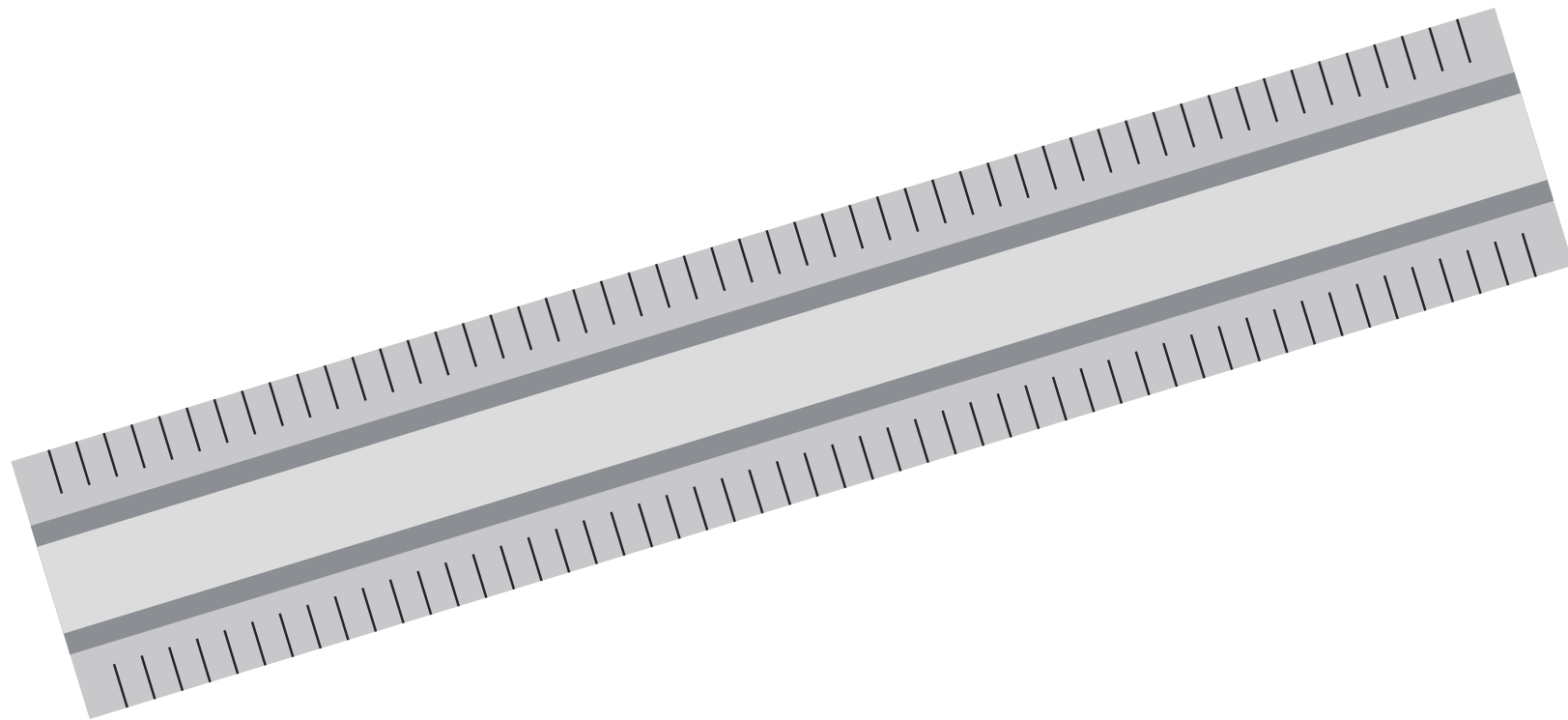

**ruler**



p'elli

**school**

you can do  
everything

**sentence**





**sit**



Jam

j-a-m

**spell**



**stand**





**story**





**teacher**



**tell**



**test**

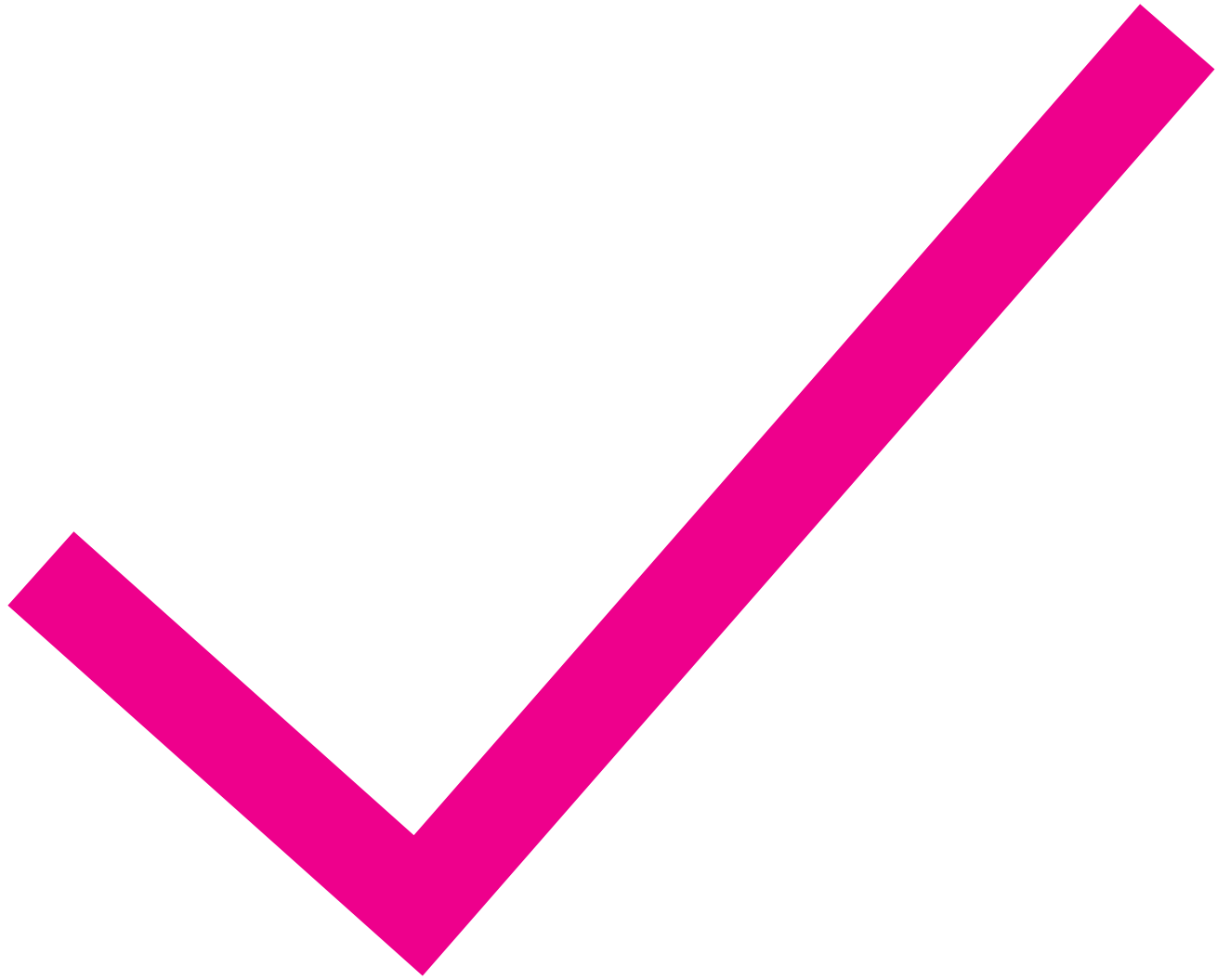

**tick**





**understand**

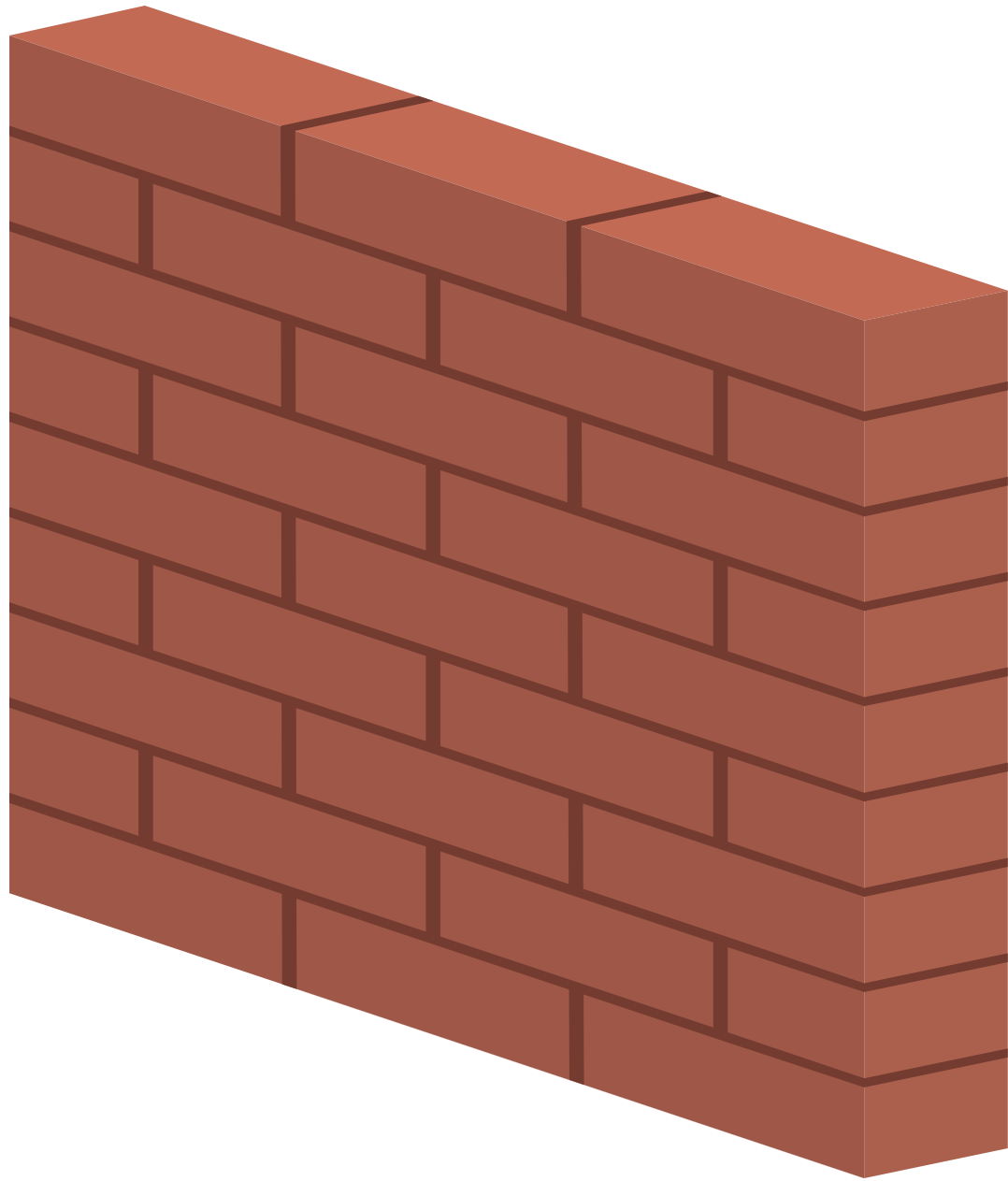

**wall**





**window**

classroom

**word**





**write**