

Amazing

3

W D Z

kindergarten



by Carmen Ramírez

Amazing Kidz 3

Serie Amazing Kidz

Libro ESL para estimulación de las habilidades comunicativas y cognitivas de los pequeños

Texto: Carmen Ramírez Pineda

Diseño: Araceli Vanessa Cruz Maya

San Cristobal, Ecatepec, Edo. Mex

Primera Edición, Mayo 2018.

Impreso en México por EnglishHouse México.

www.englishhouse.mx

Esta obra tiene todos los derechos reservados. Se prohíbe la reproducción total o parcial sea cual fuere el medio, sin el consentimiento por escrito del titular de los derechos correspondientes.



Introduction

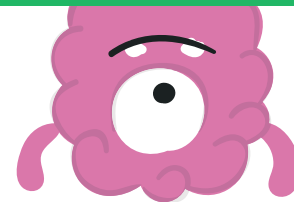

Amazing kidz

Is a new series of books for the youngest children that are ready to start the adventure of learning a second language.

The books contain coloured activities to keep learners' attention and practice pages in black and white to reinforce each lesson. These activities facilitate the children's language acquisition process.

STRUCTURE

Three-level kindergarten course:

Amazing kidz 1 (3 years)

Amazing kidz 2 (3.5-4.5 years)

Amazing kidz 3 (4.5-5.5 years)

Each book has 6 units with 162 lessons in total.



COMPONENTS

Amazing kidz consists of the following components for students and teacher use and all together make up a fun and attractive program.

Reading stories (Amazing kids 3)

Base book

Teacher's guide

Cutouts

Flashcards

Wordcards (Reading by word project)



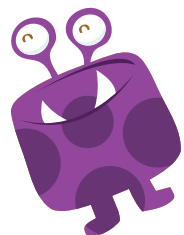

Contents



	Unit	Page
1	School is Fantastic!	05
2	My Body!	40
3	This is My Family!	74
4	Yummy, Yummy!	107
5	Discovering Places	139
6	Fantastic Animals	173
7	Holidays	207

Unit 1

School is Fantastic!

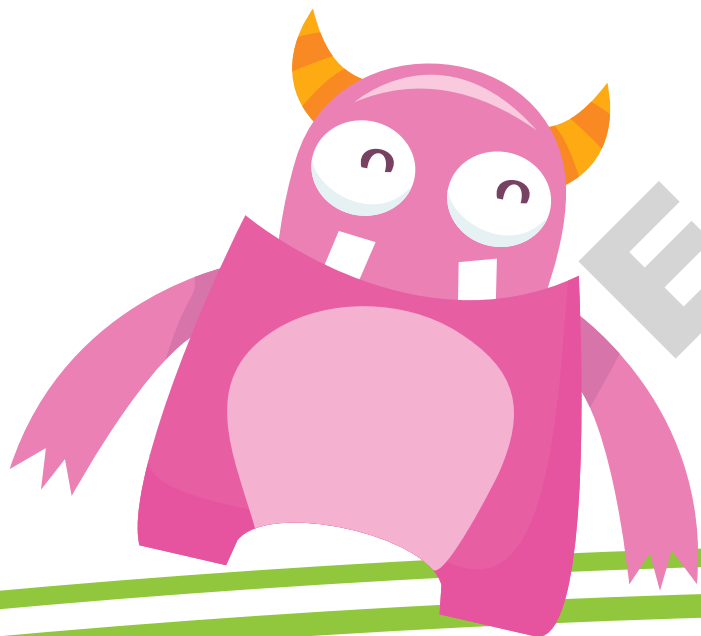

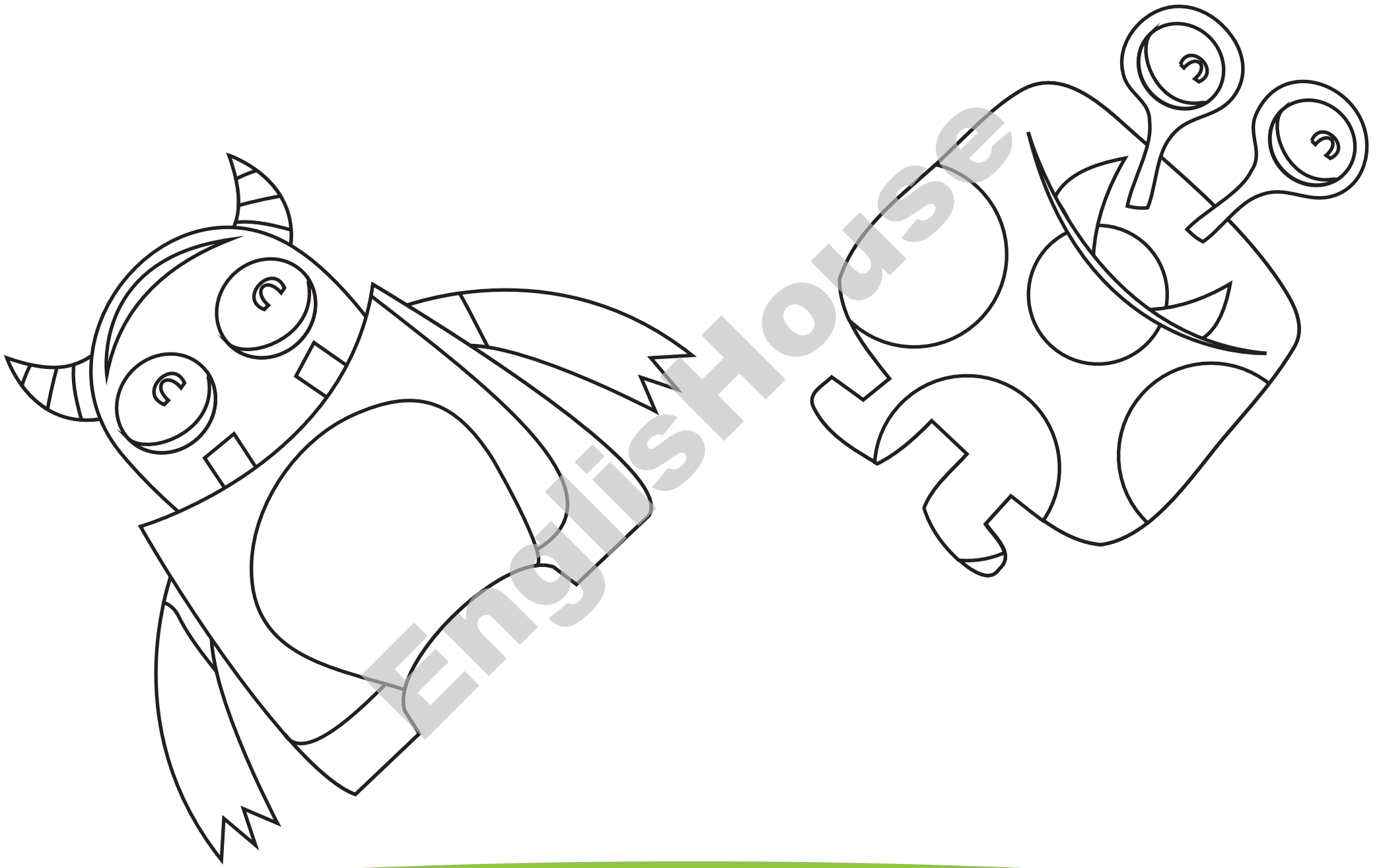

Trace, draw and colour.



girl

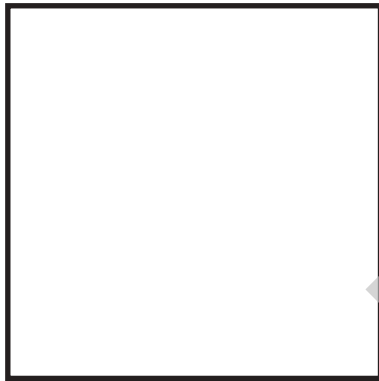

me

school



boy



teacher

Lesson 01



Trace, read, and match.

What's this?

It's a book

It's a pencil

It's a backpack

It's a crayon



Lesson 02

Look, trace, colour, cut and paste.

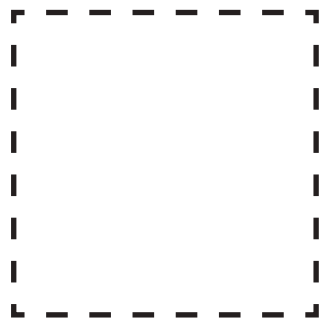

crayon

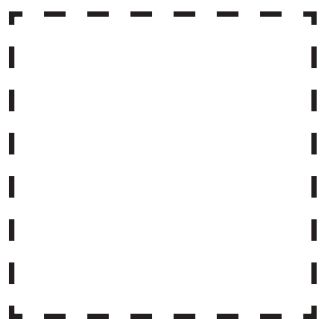

scissors

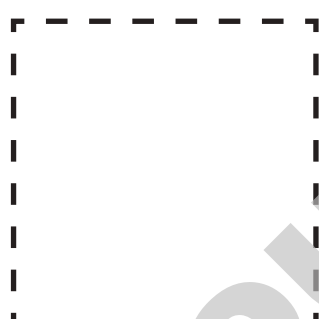

pencil

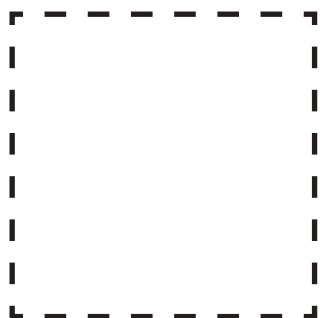

pencil

case



book

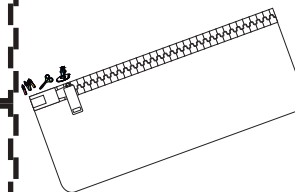
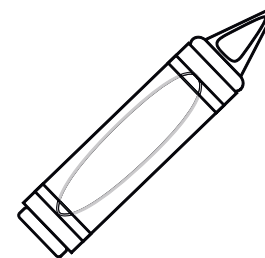
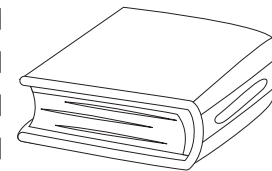
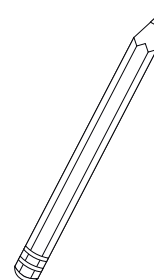
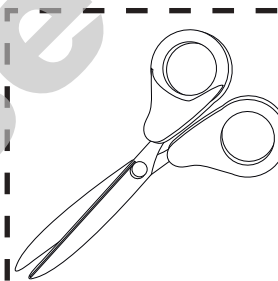

Lesson 03

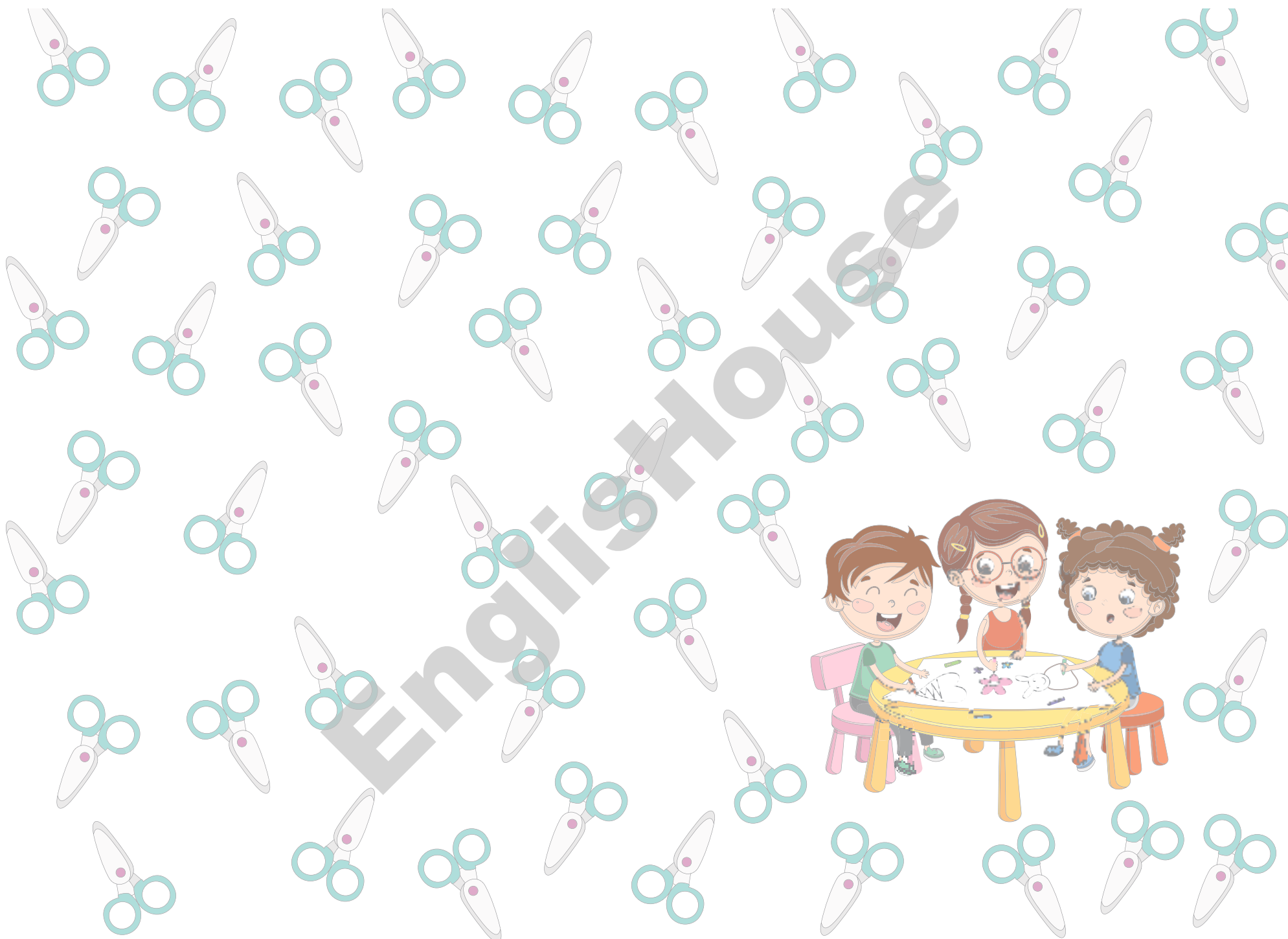

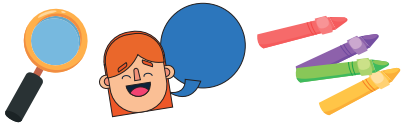

Look, name and colour.



Lesson 04



Listen and colour / then draw yourself and colour.

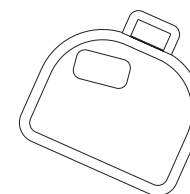
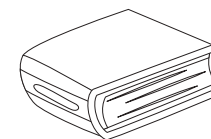
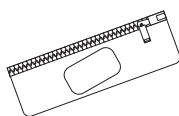
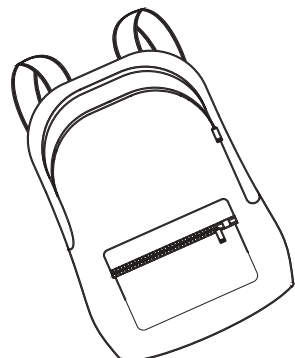
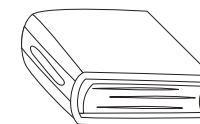
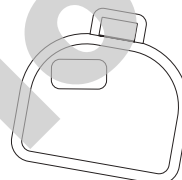
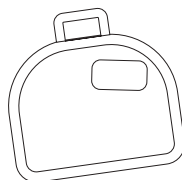
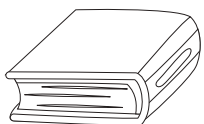
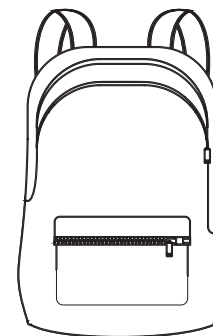
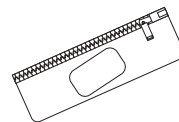
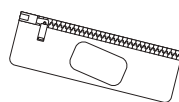
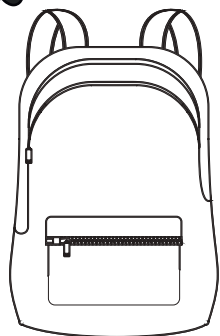

Lesson 05

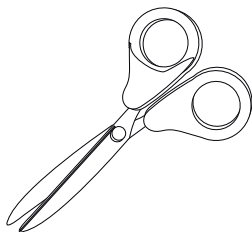
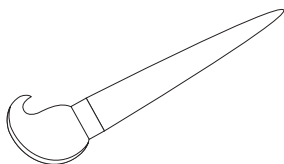
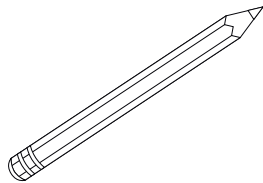

Match, colour and name.

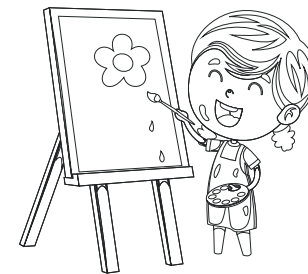

EnglishHouse

Lesson 06



My name is Tom
I'm a boy



I'm 4 years old.

Write, draw and colour.

I like



My name is Emily
I'm a girl



I'm 5 years old.

I like



My name is _____
I'm a _____



I'm _____ years old.

I like

Lesson 07

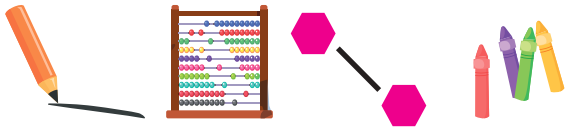

Trace, count, match and colour.

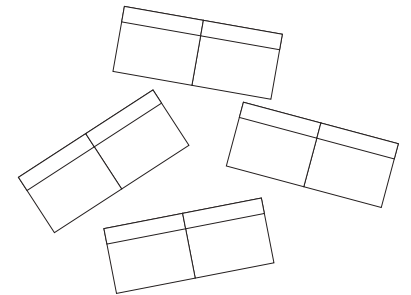
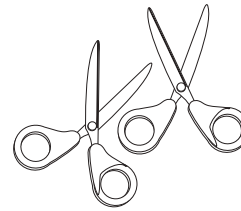
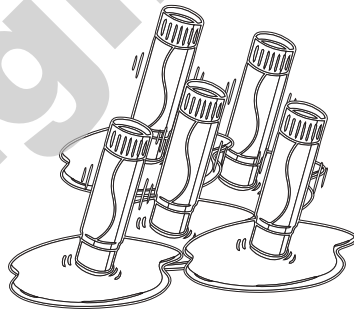
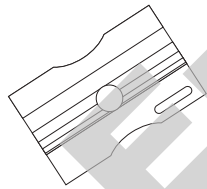
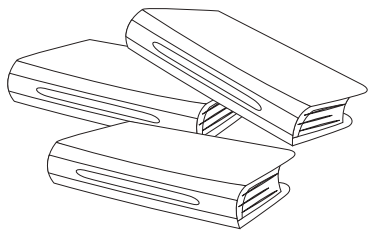
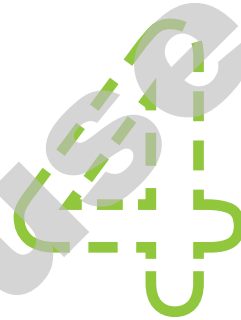
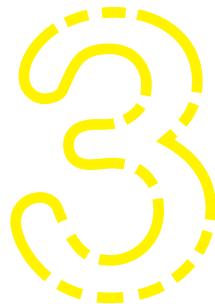

Lesson 08

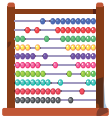

Count, write and colour.

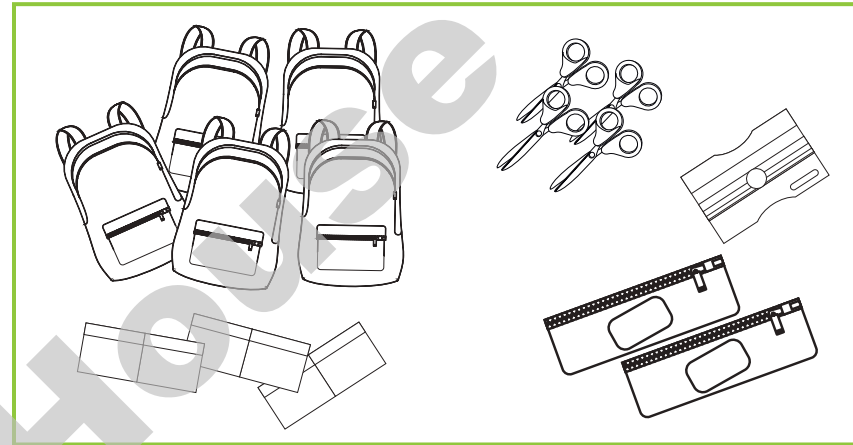

How many  ? _____

How many  ? _____

How many  ? _____

How many  ? _____

How many  ? _____

Lesson 09



Cut, listen, paste, write and say.



M _____



T _____



W _____



T _____



F _____

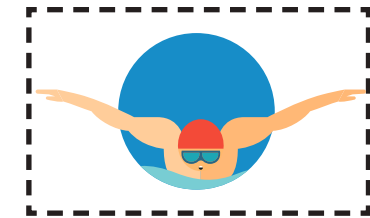
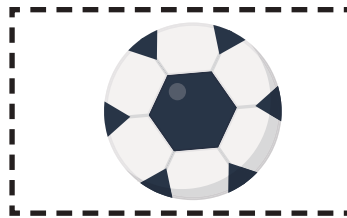
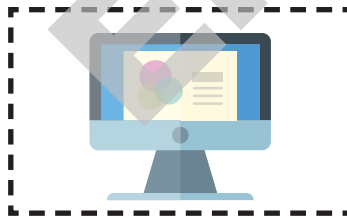

Lesson 10

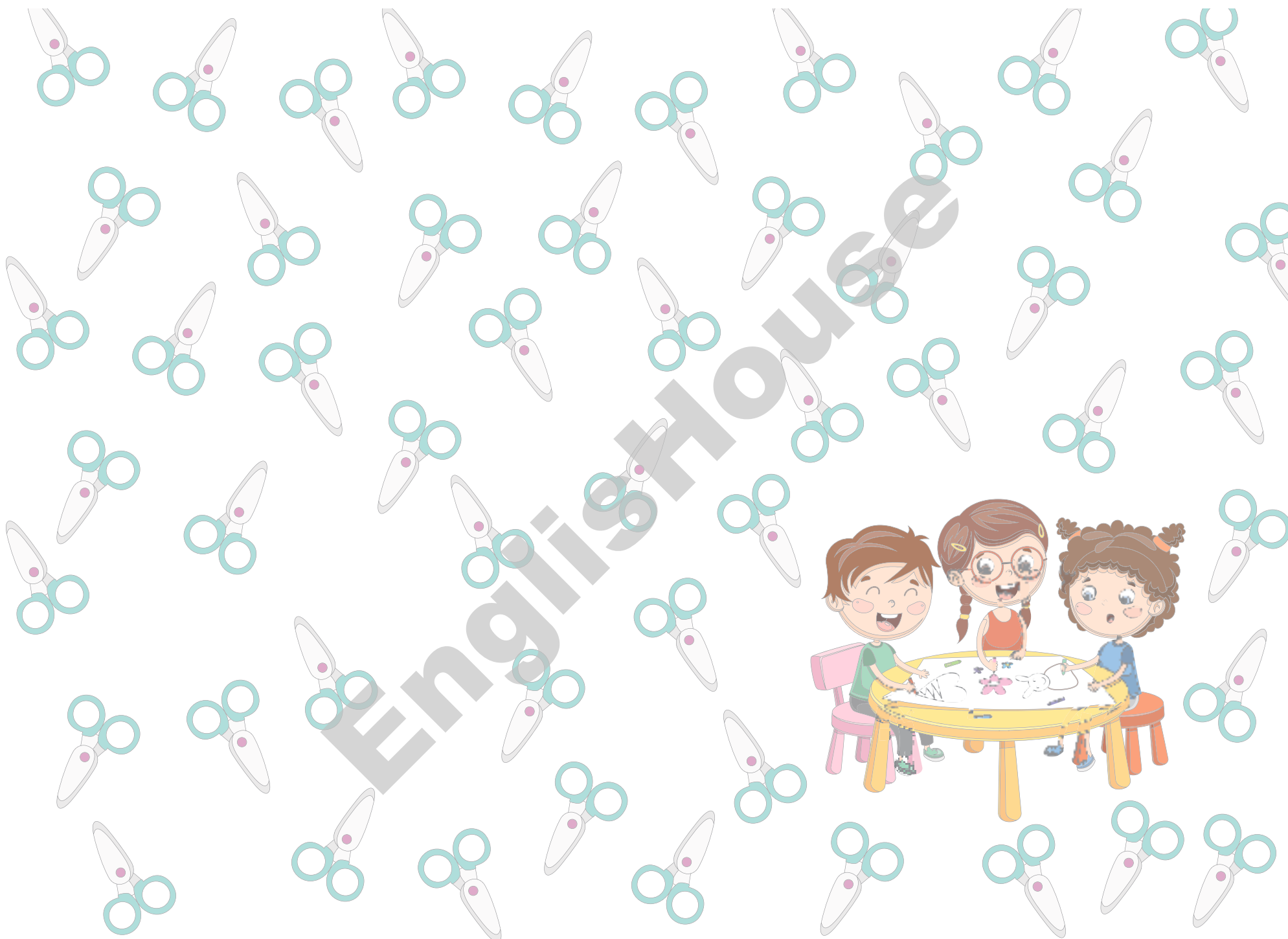



Look, trace and colour.

Monday Tuesday Wednesday



Thursday Friday



Monday



Tuesday



Wednesday



Thursday



Friday



Lesson 11



Draw and colour.

My favourite class is...

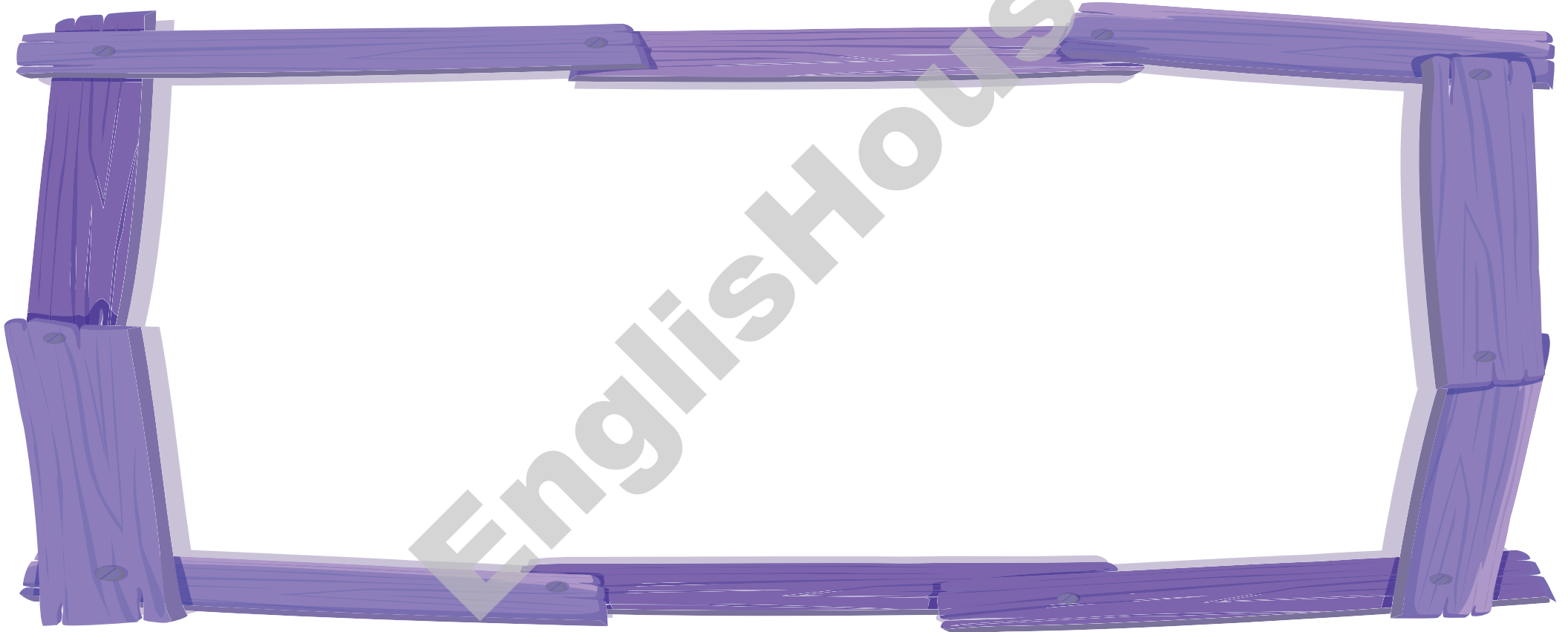

Lesson 12



Look and colour.

I like special classes

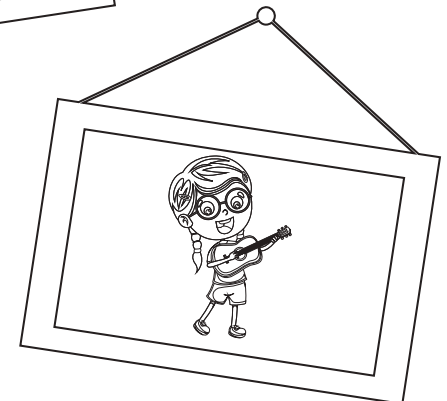
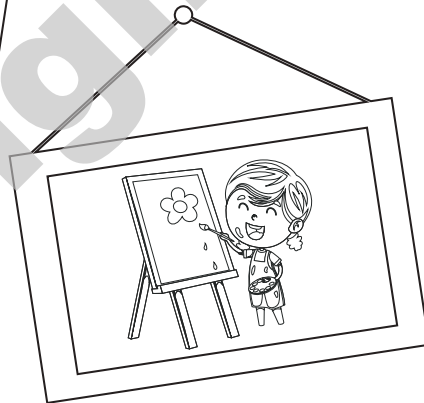
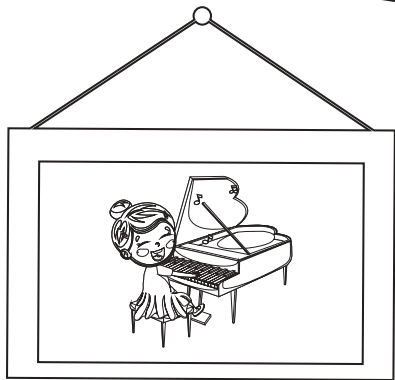
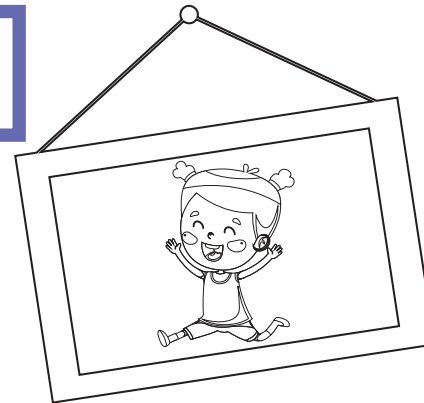
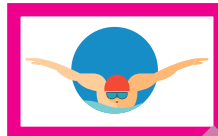

Lesson 13



Art

PE

Music

Trace, read and match.



Lesson 14



Colour, cut and paste.



I like...



I don't like...

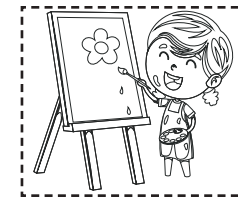
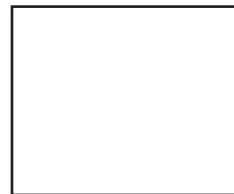
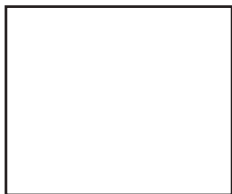
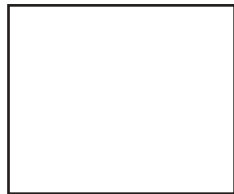

Lesson 15



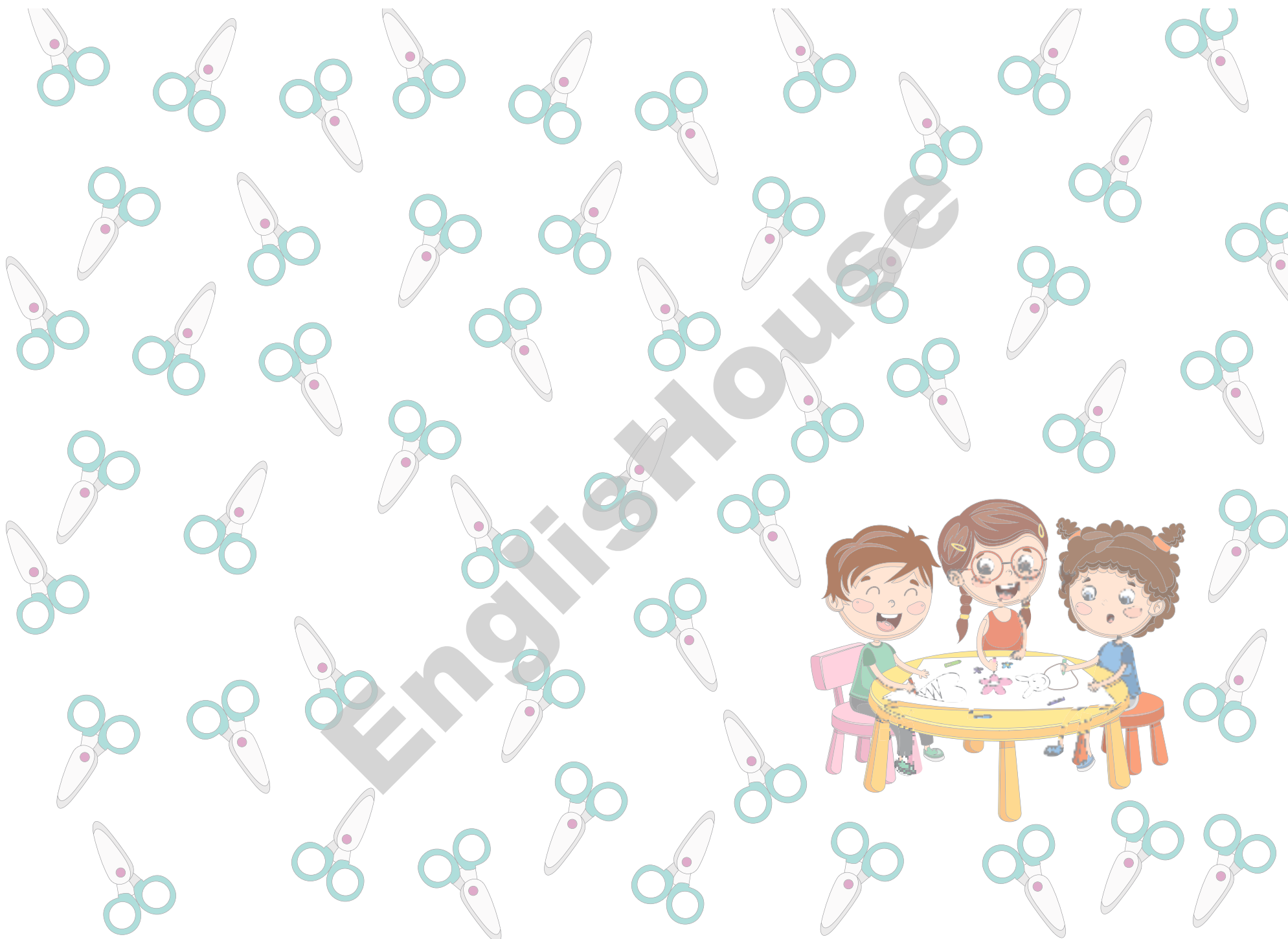



Write, cut, listen and paste.

Monday

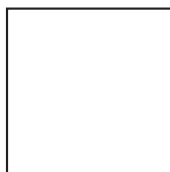

T

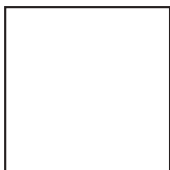

W



Th



F

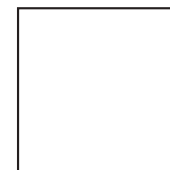

S

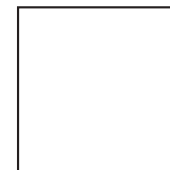

S

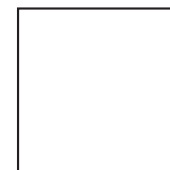

Lesson 16

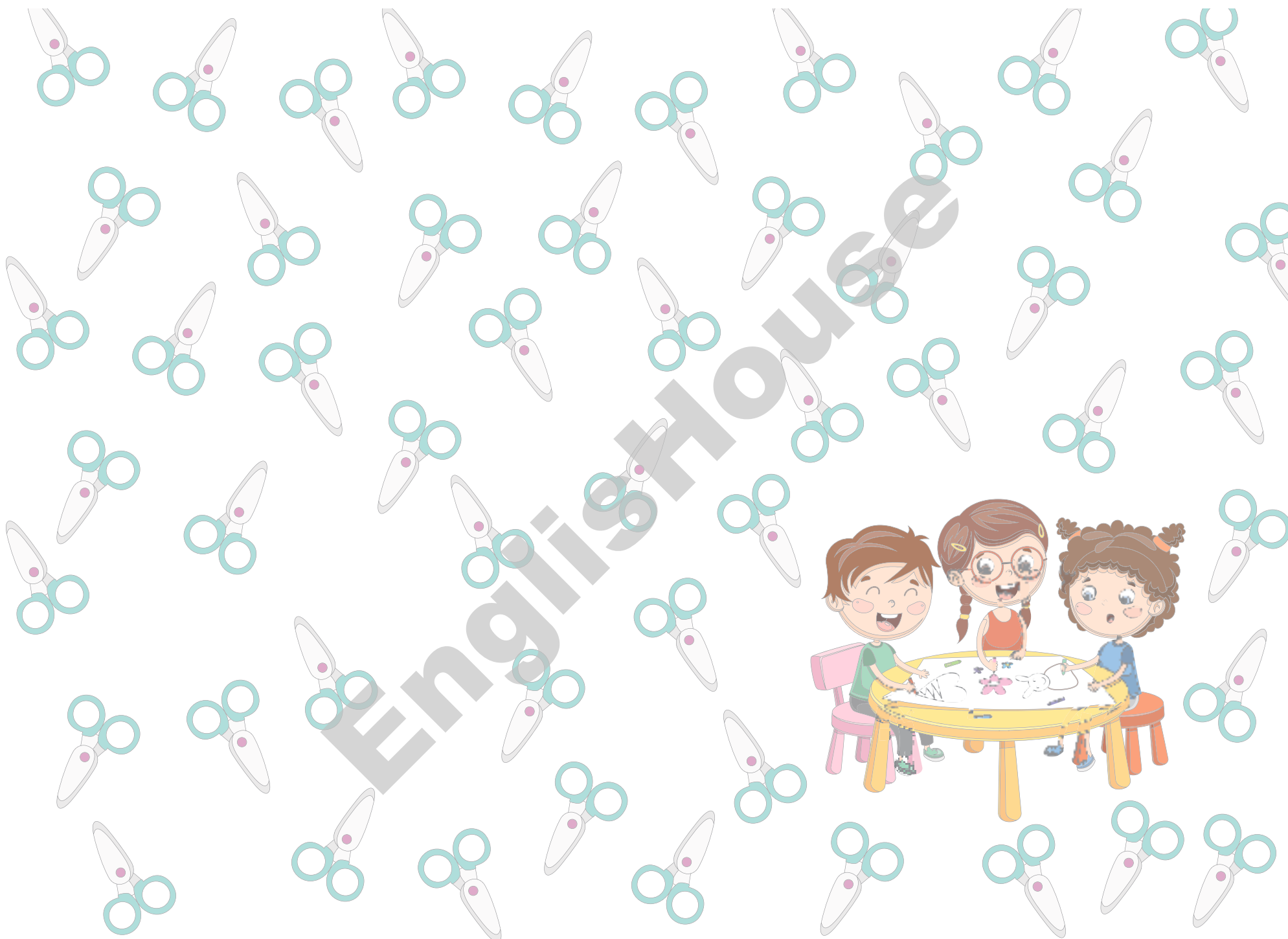



Listen, follow and colour.

Saturday



Sunday

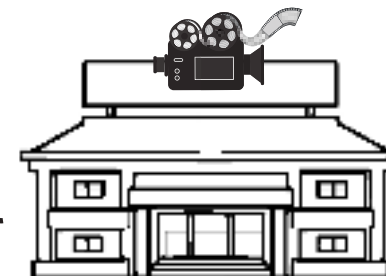

Lesson 17



Colour and play.

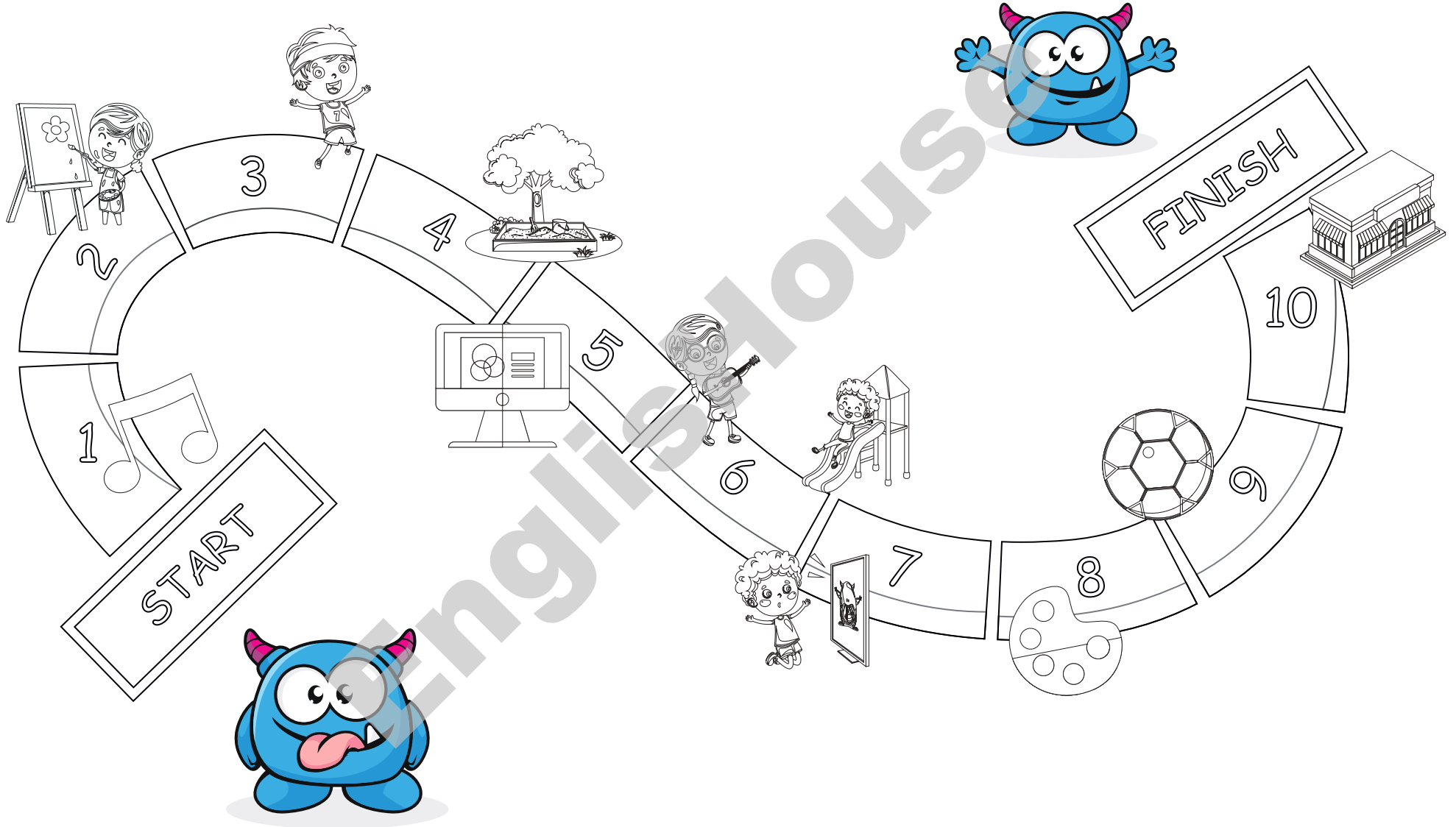

Lesson 18



Look and colour.



Lesson 19



Listen and circle.



Lesson 20



Listen, colour, cut and assemble.

What time is it?

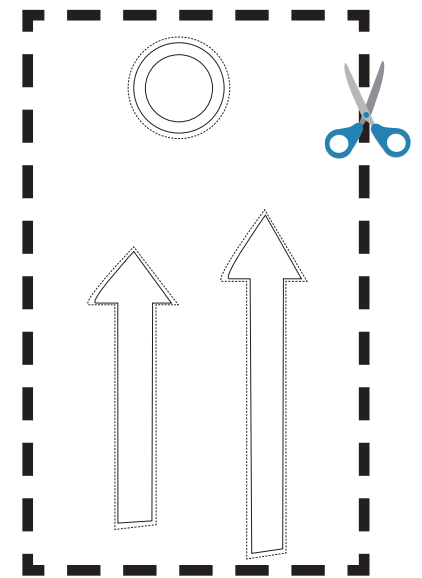
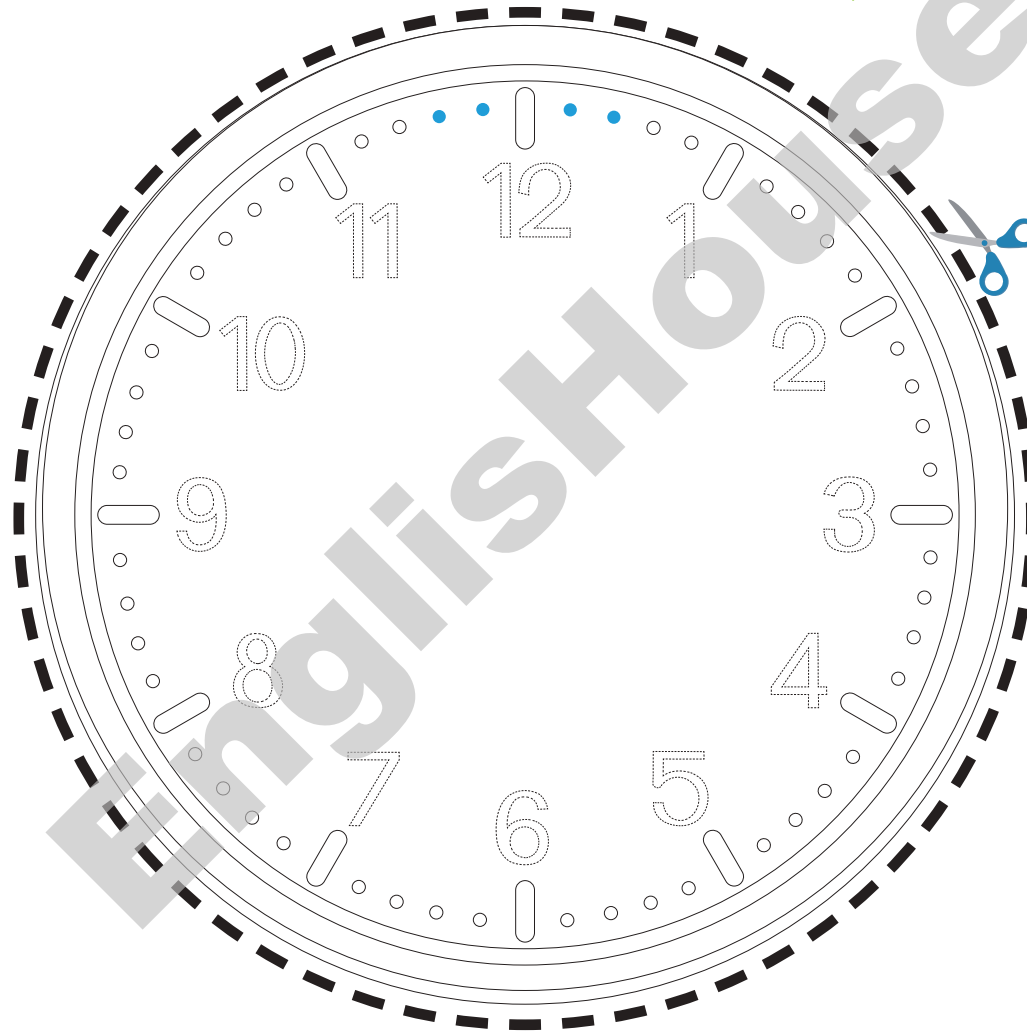

Lesson 21

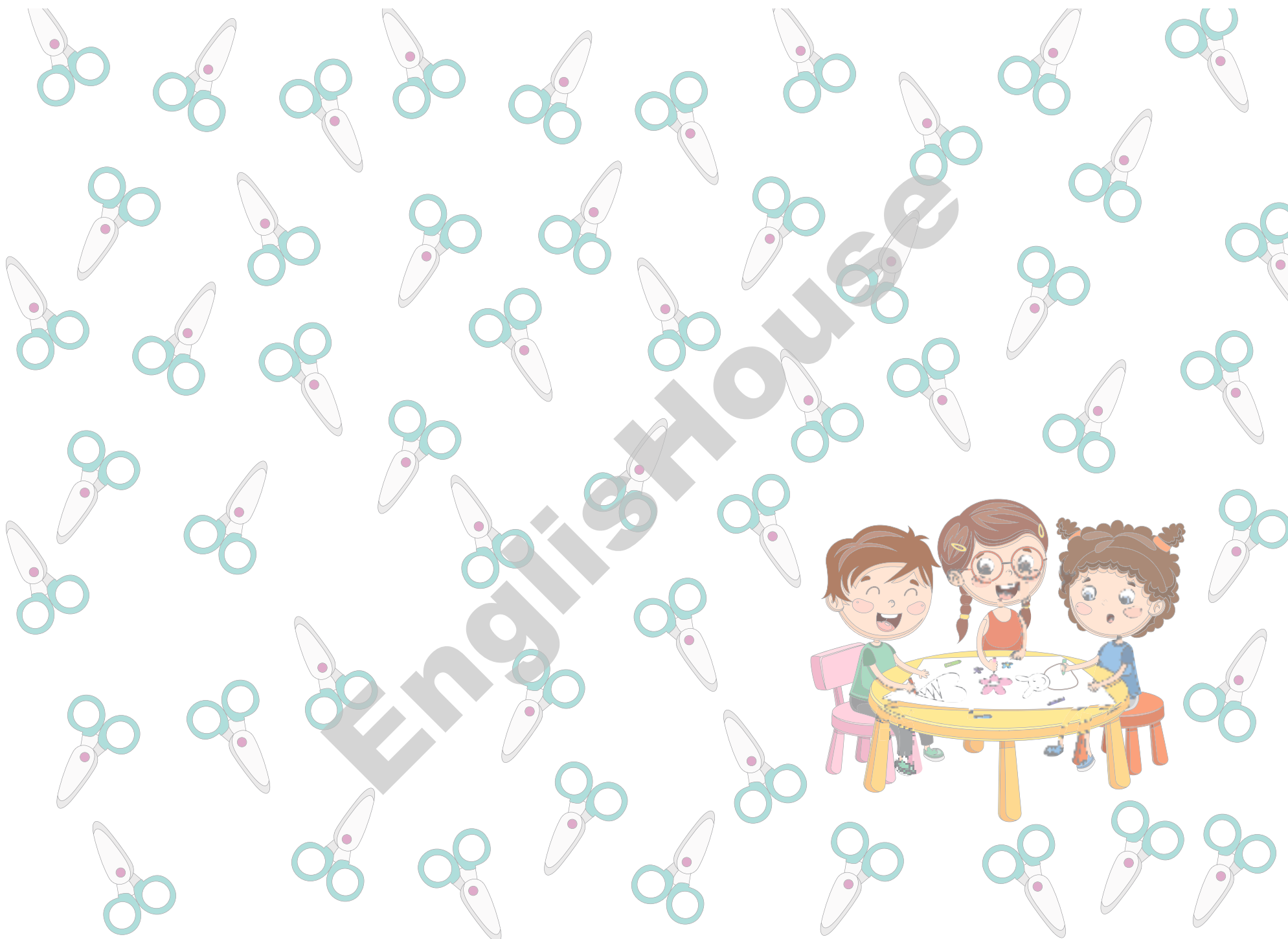



Read and write.

What time is it?



It's _____ o'clock.

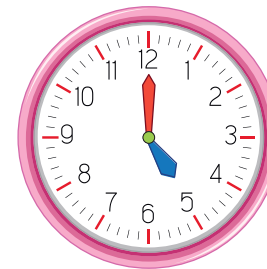

It's _____ o'clock.



It's _____ o'clock.



It's _____ o'clock.

Lesson 22



Listen and colour.



Lesson 23



Look and colour.

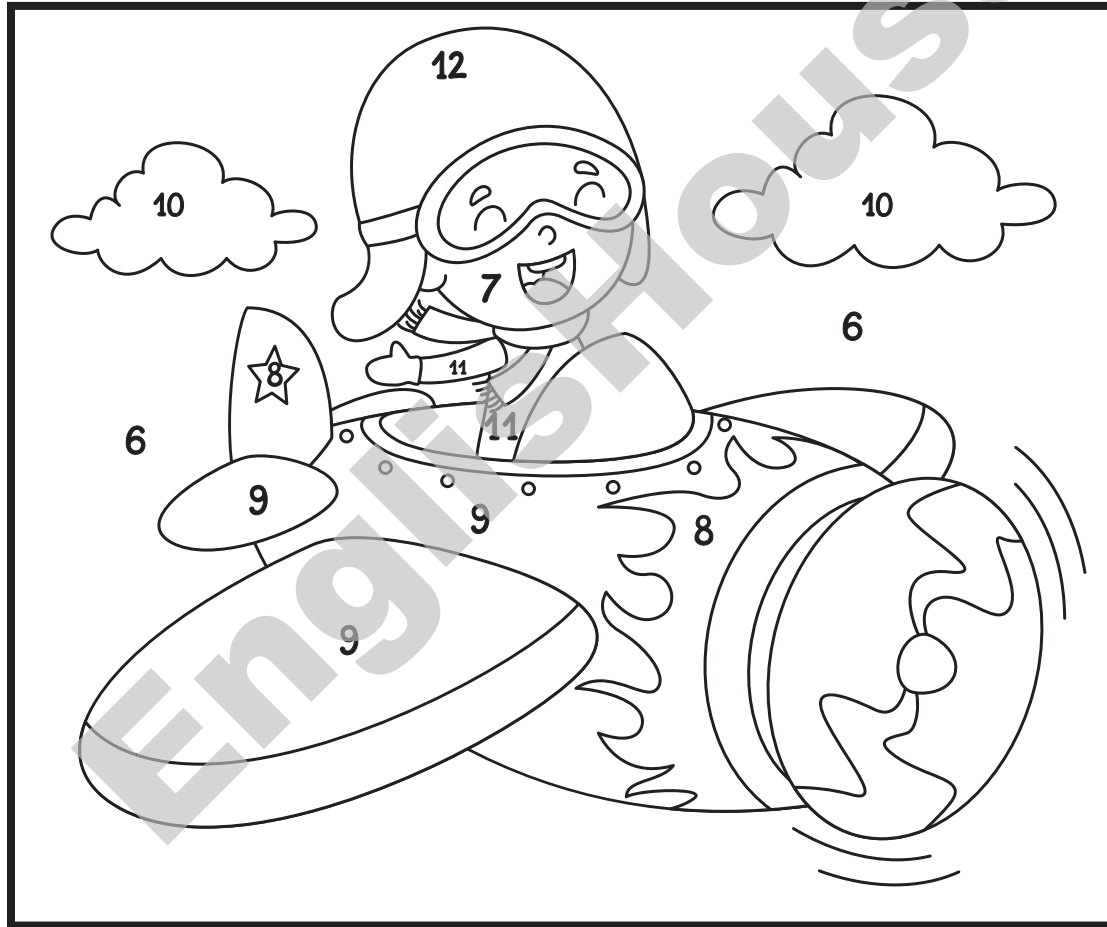
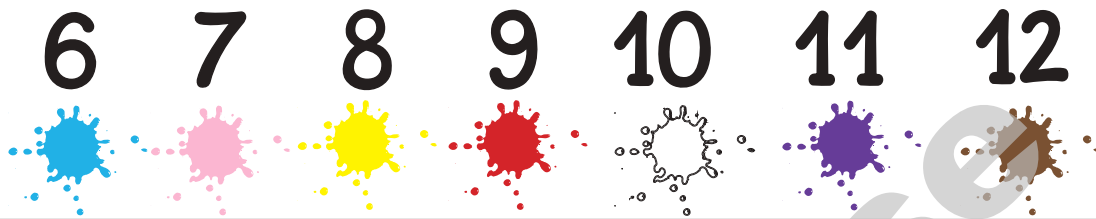

Lesson 24

Show What You
Know!





Listen and cross out.

1

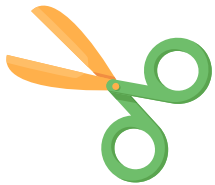

2

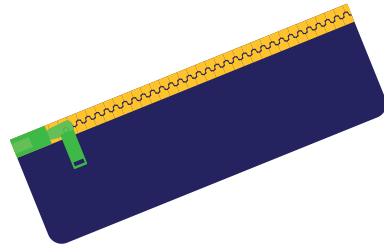

3



4



5



Lesson 25



Listen and colour.

Monday

Tuesday

Wednesday

Thursday

Friday

Saturday

Sunday

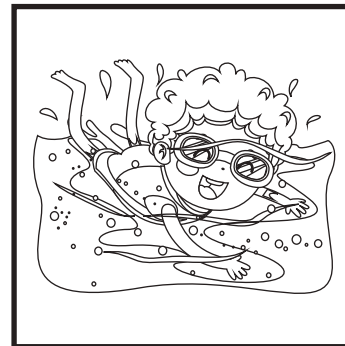
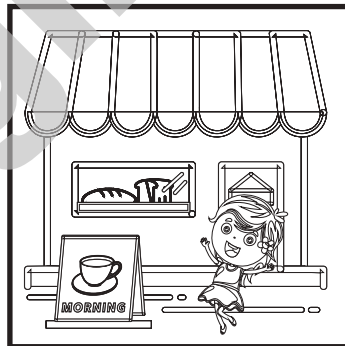
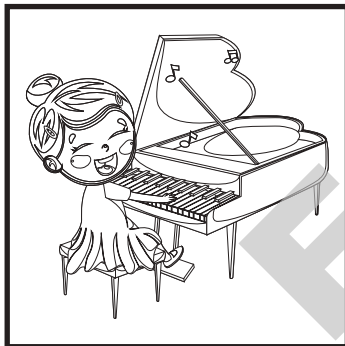
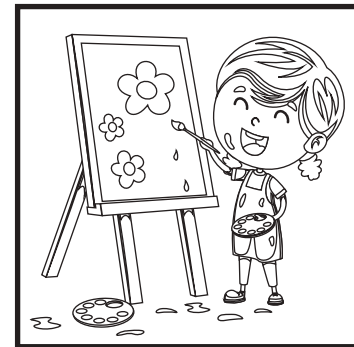
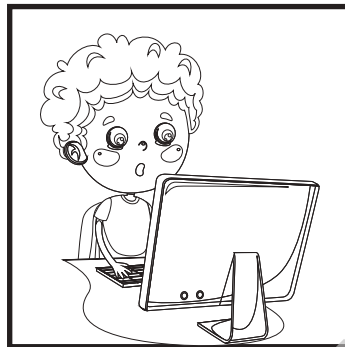

Lesson 26



Read, draw and colour.

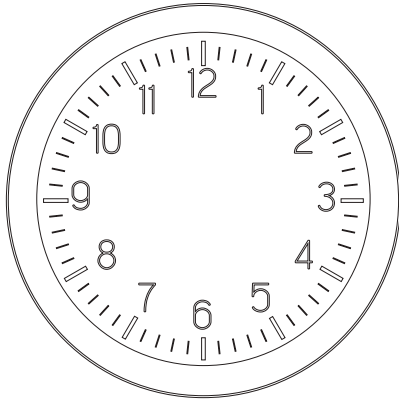

It's two o'clock.

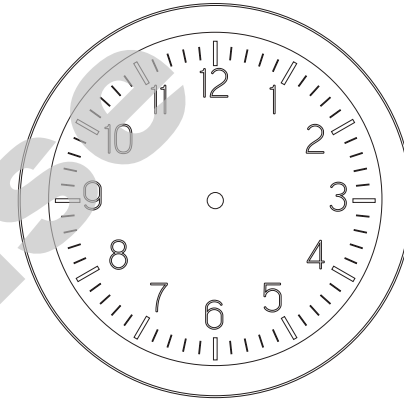

It's five o'clock.

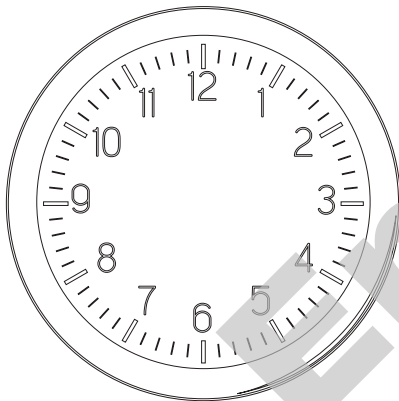

It's four o'clock.

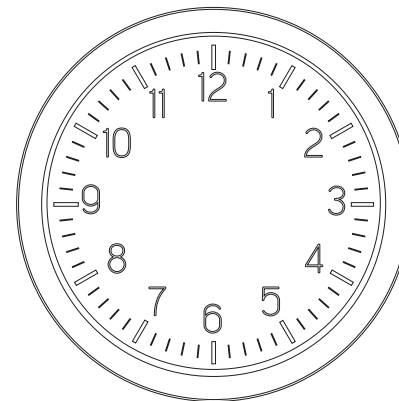

It's one o'clock.

Lesson 27

Unit 2

My Body!





Trace, colour, look and write.

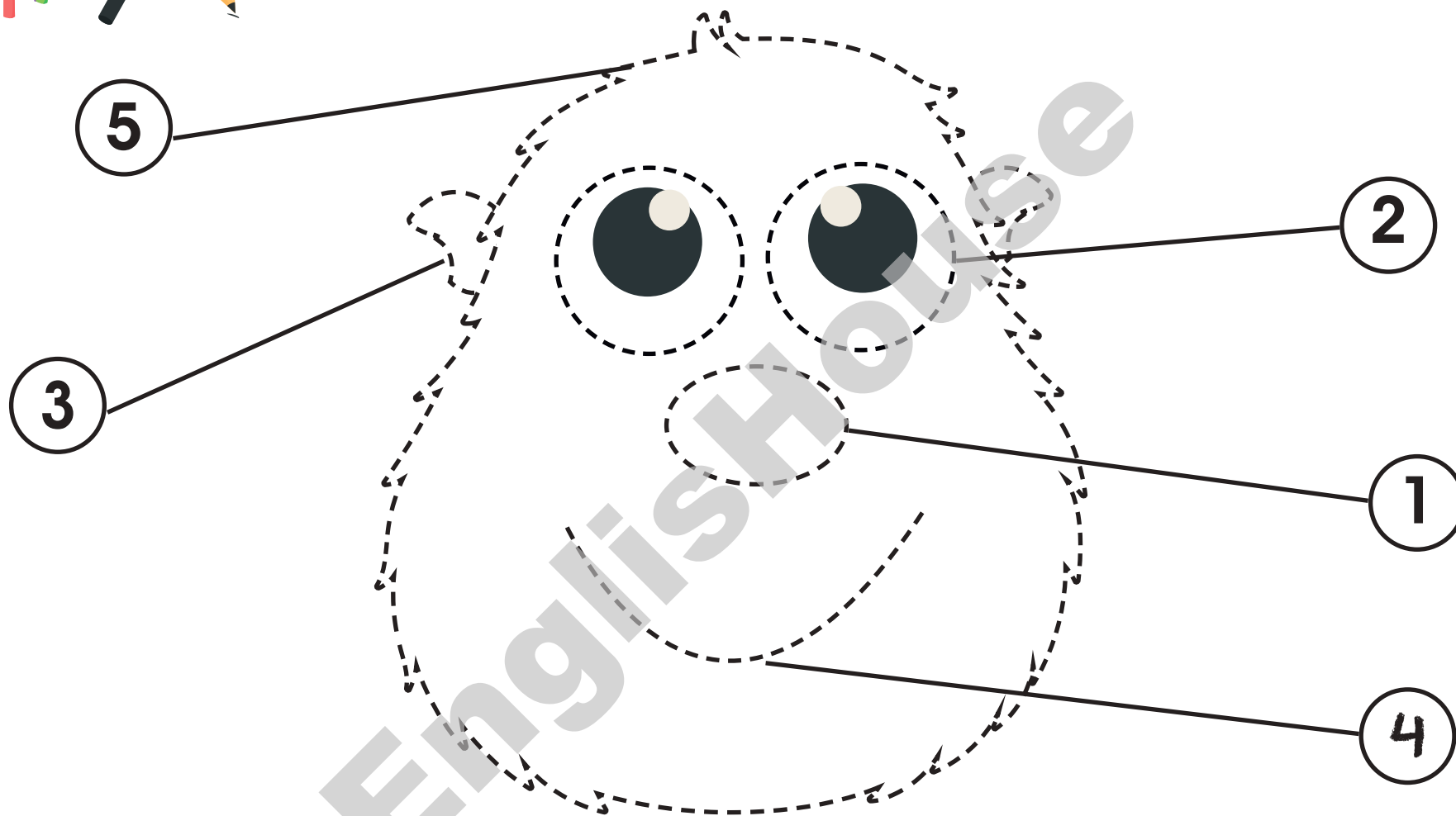

4 mouth eye nose hair ear

Lesson 01



Trace, match and colour.

neck

arm

shoulder

head



leg

hand

knee

foot

Lesson 02

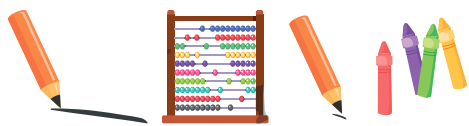

Trace, count, write and colour.

How many?

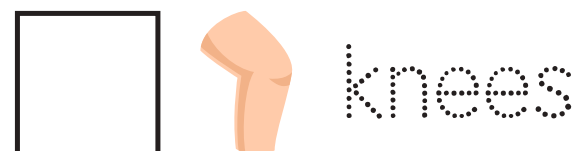
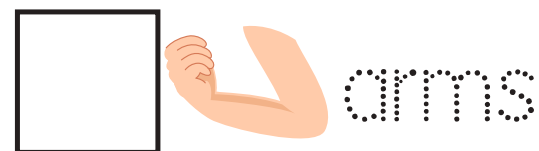
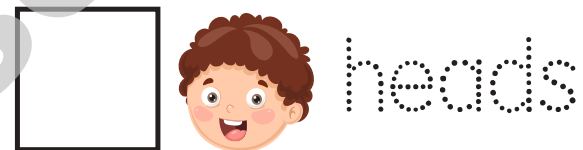
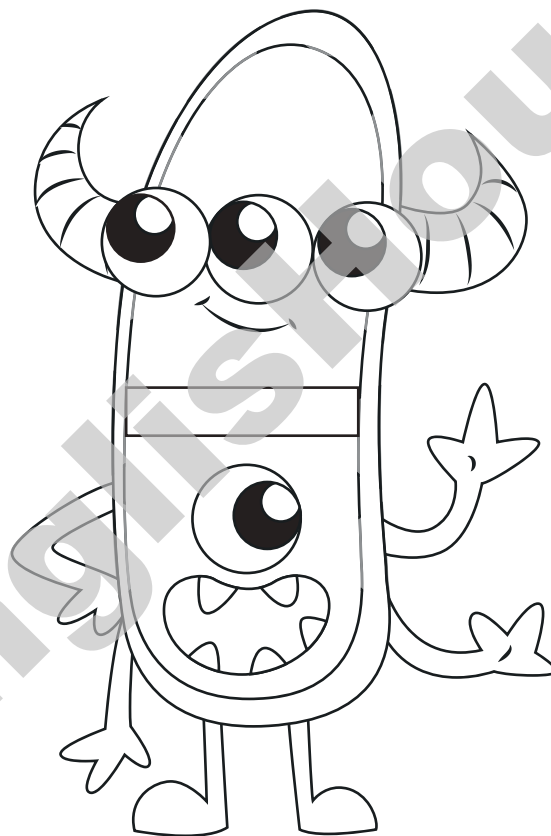
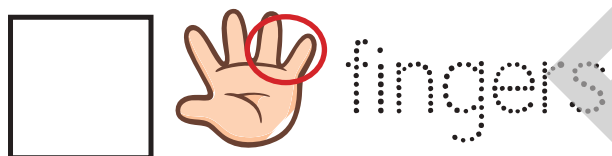
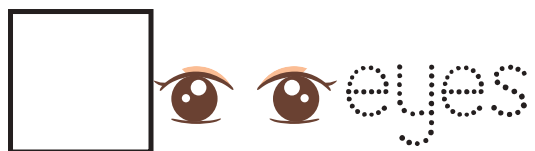
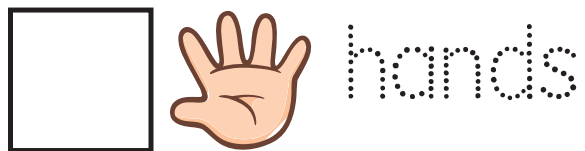

Lesson 03



Trace and colour.

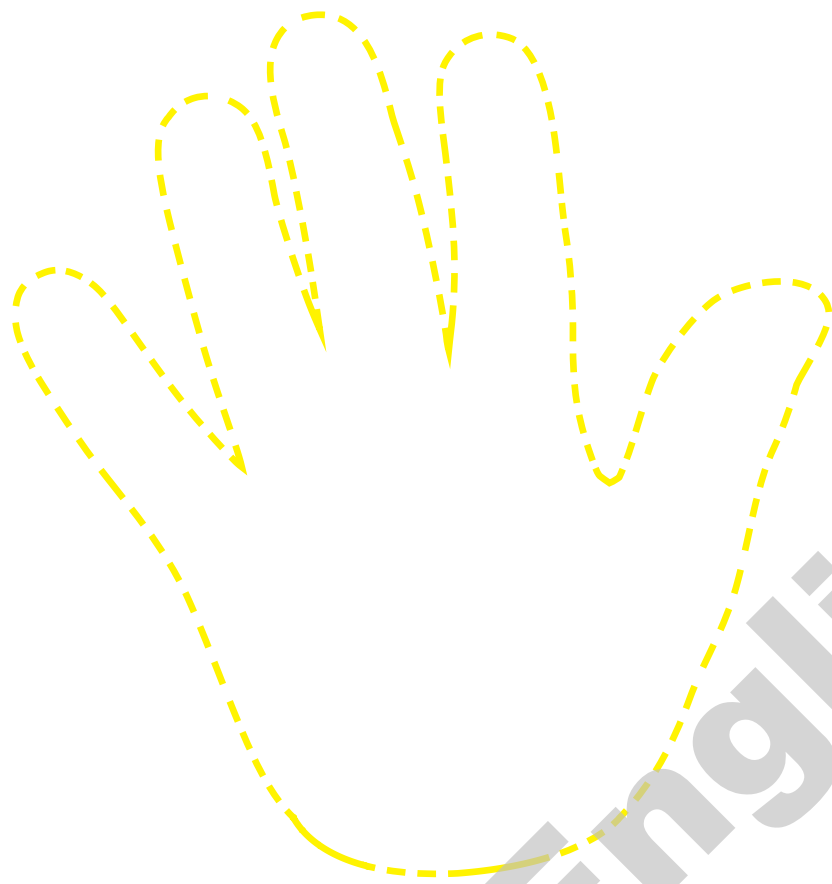

left hand

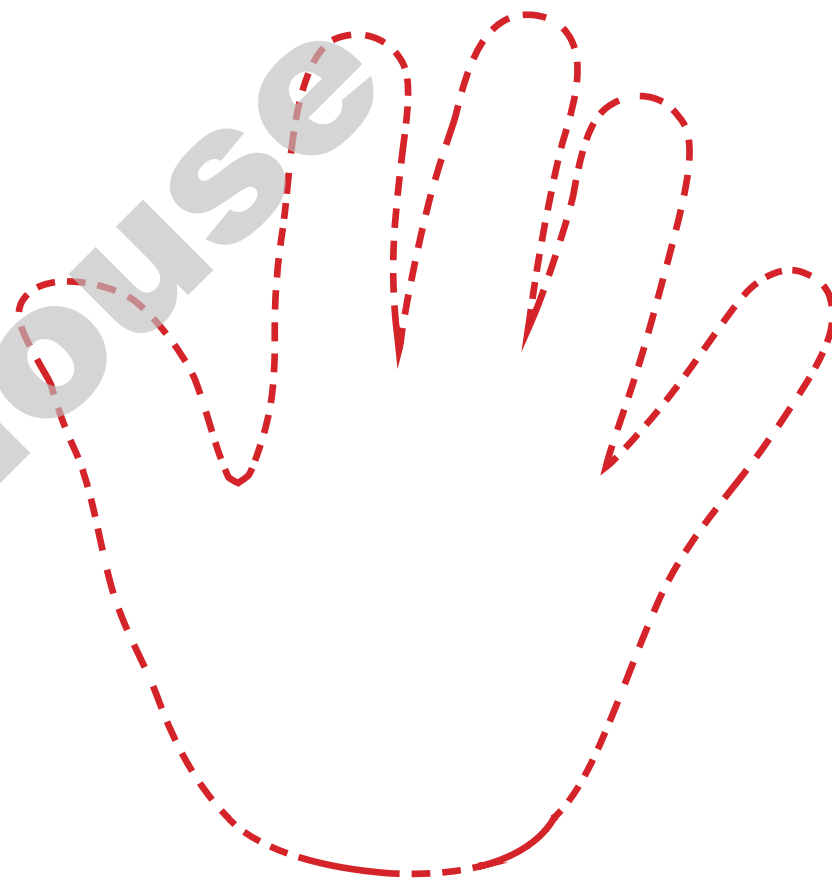

right hand

Lesson 04



Colour, cut and paste.

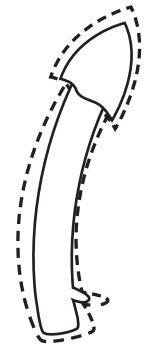
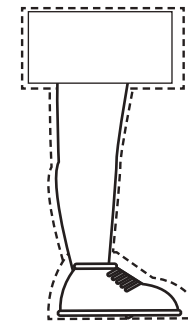
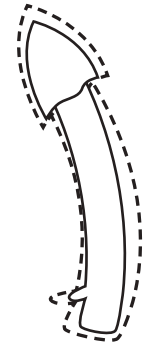
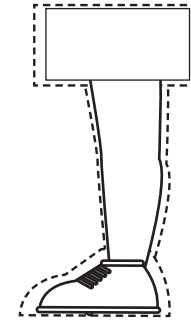

Lesson 05

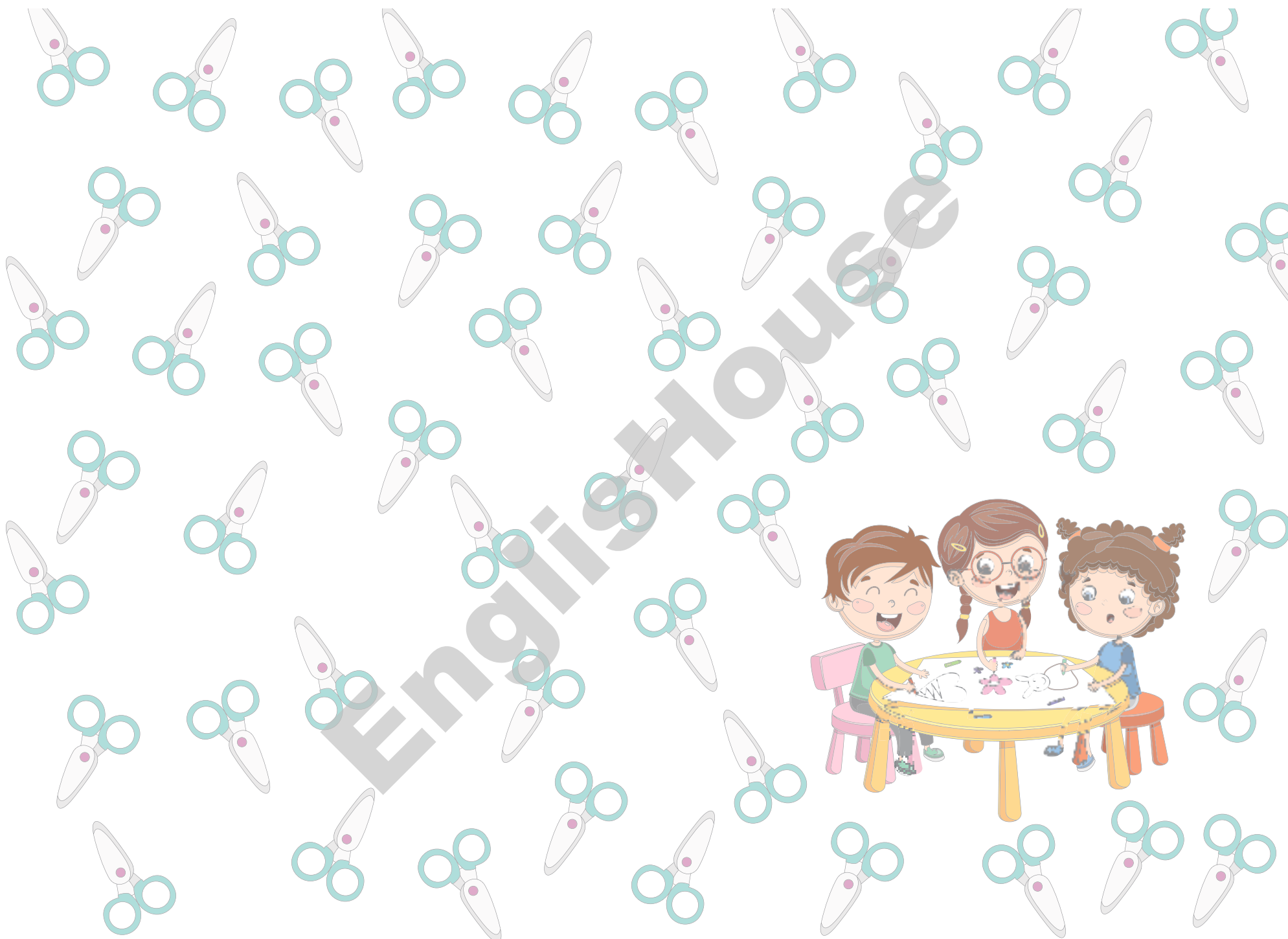

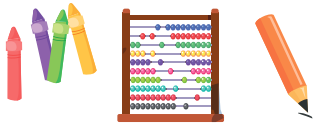

Colour, count and write.

left

right

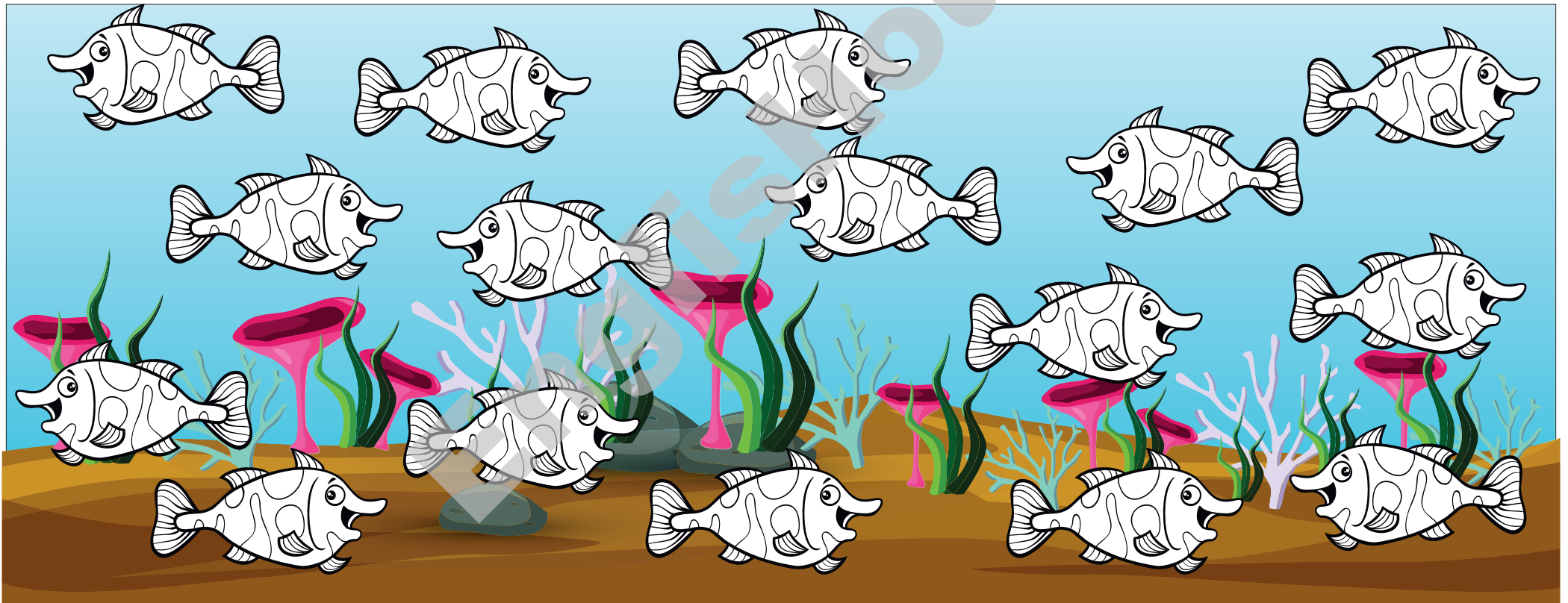

Lesson 06

Trace and colour.



sight

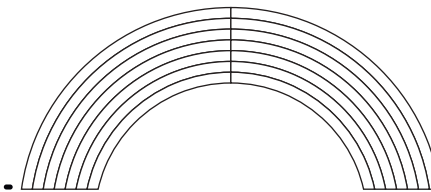
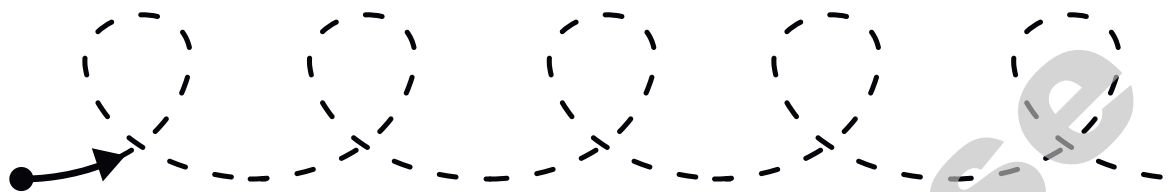

smell

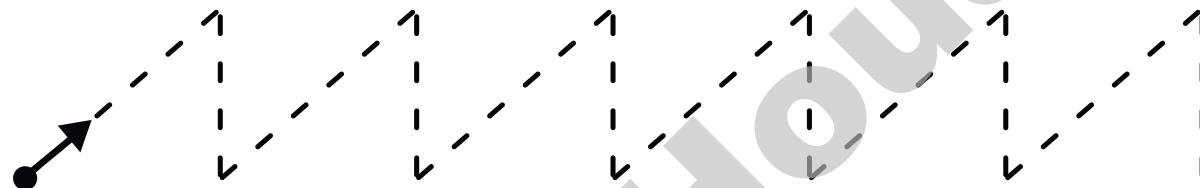

touch

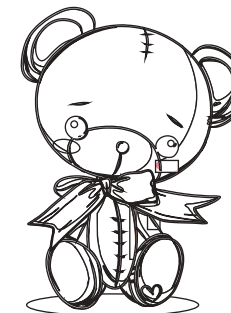

hearing



Lesson 07



Draw and colour.



smell

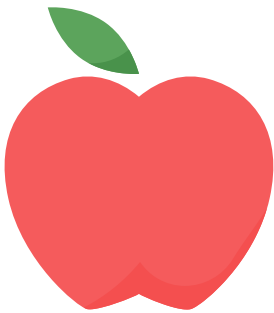

taste

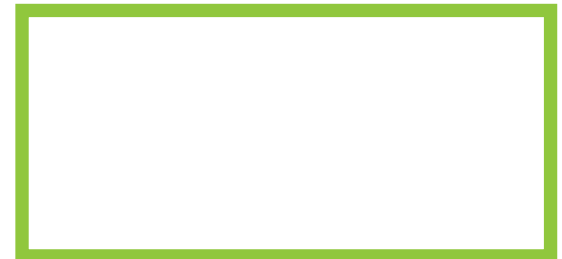

hearing



Lesson 08



Listen, point and colour.

My senses

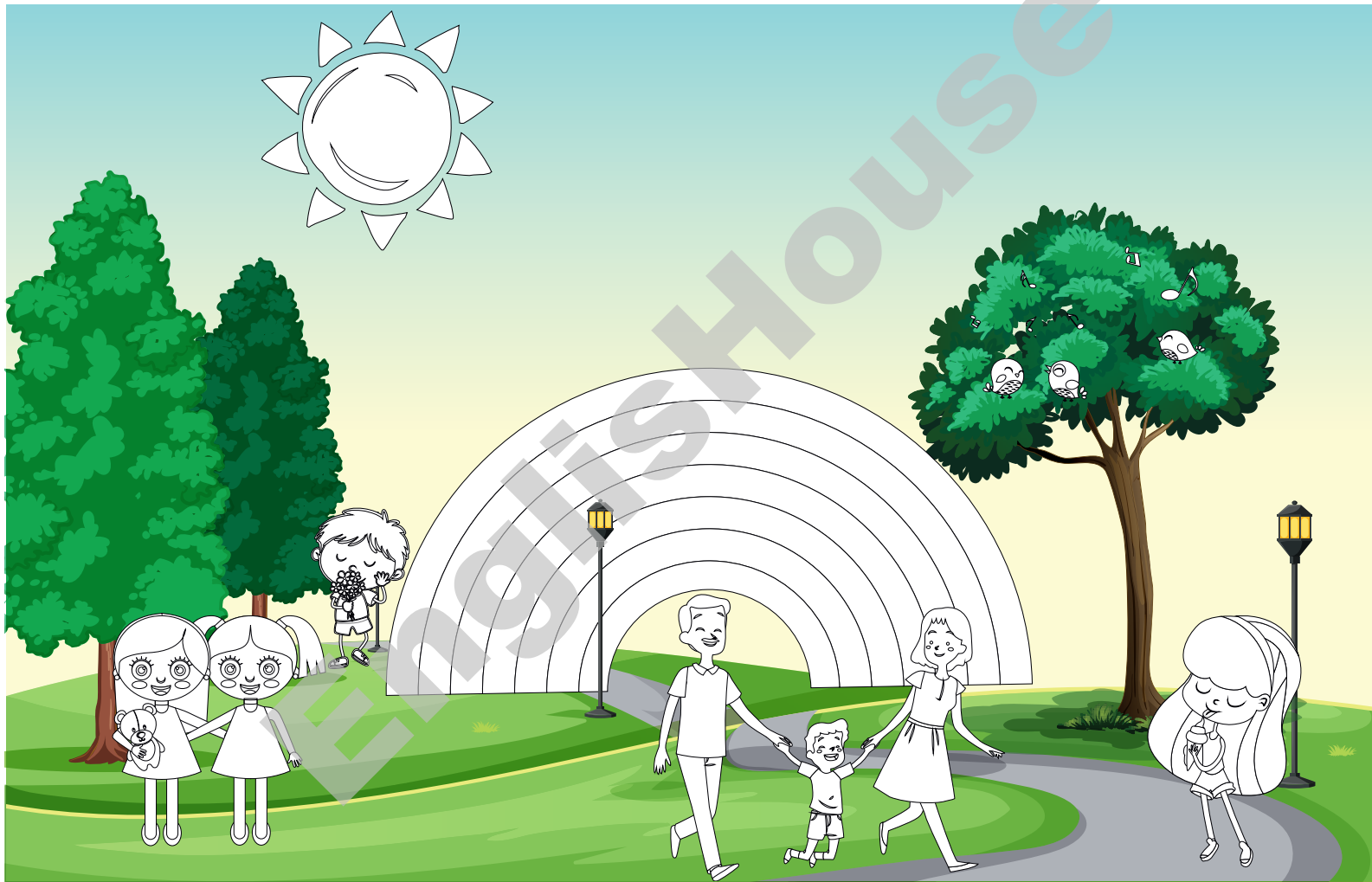

Lesson 09



Trace, colour, cut and paste.

soft

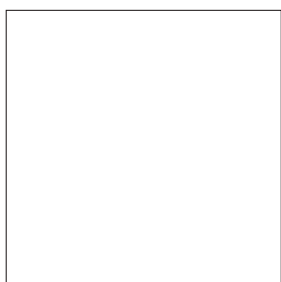

hard

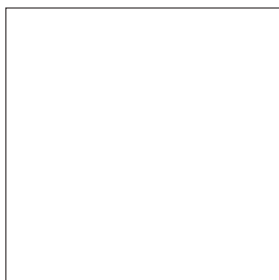

smooth



rough

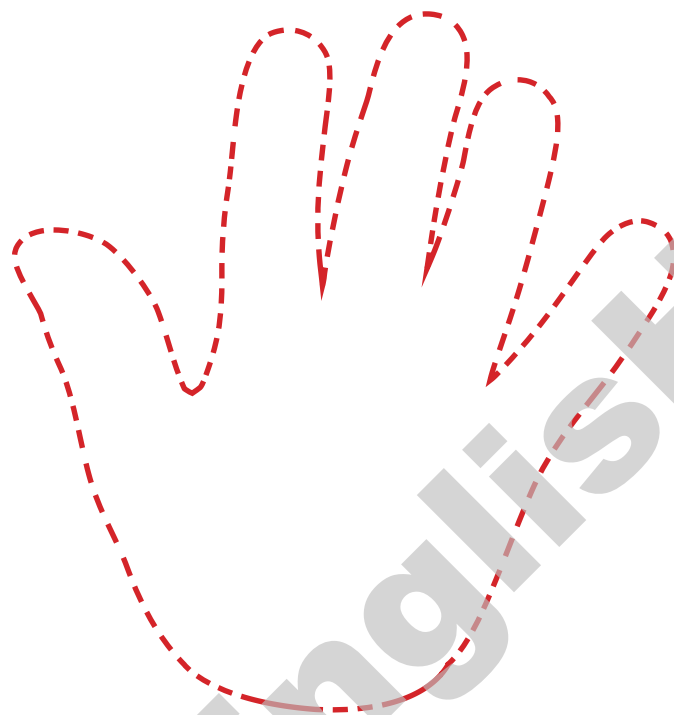

touch

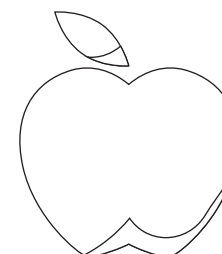
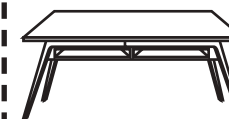
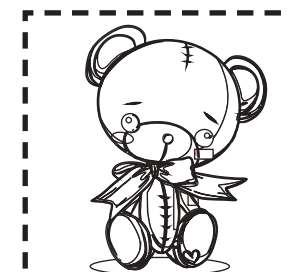

Lesson 10

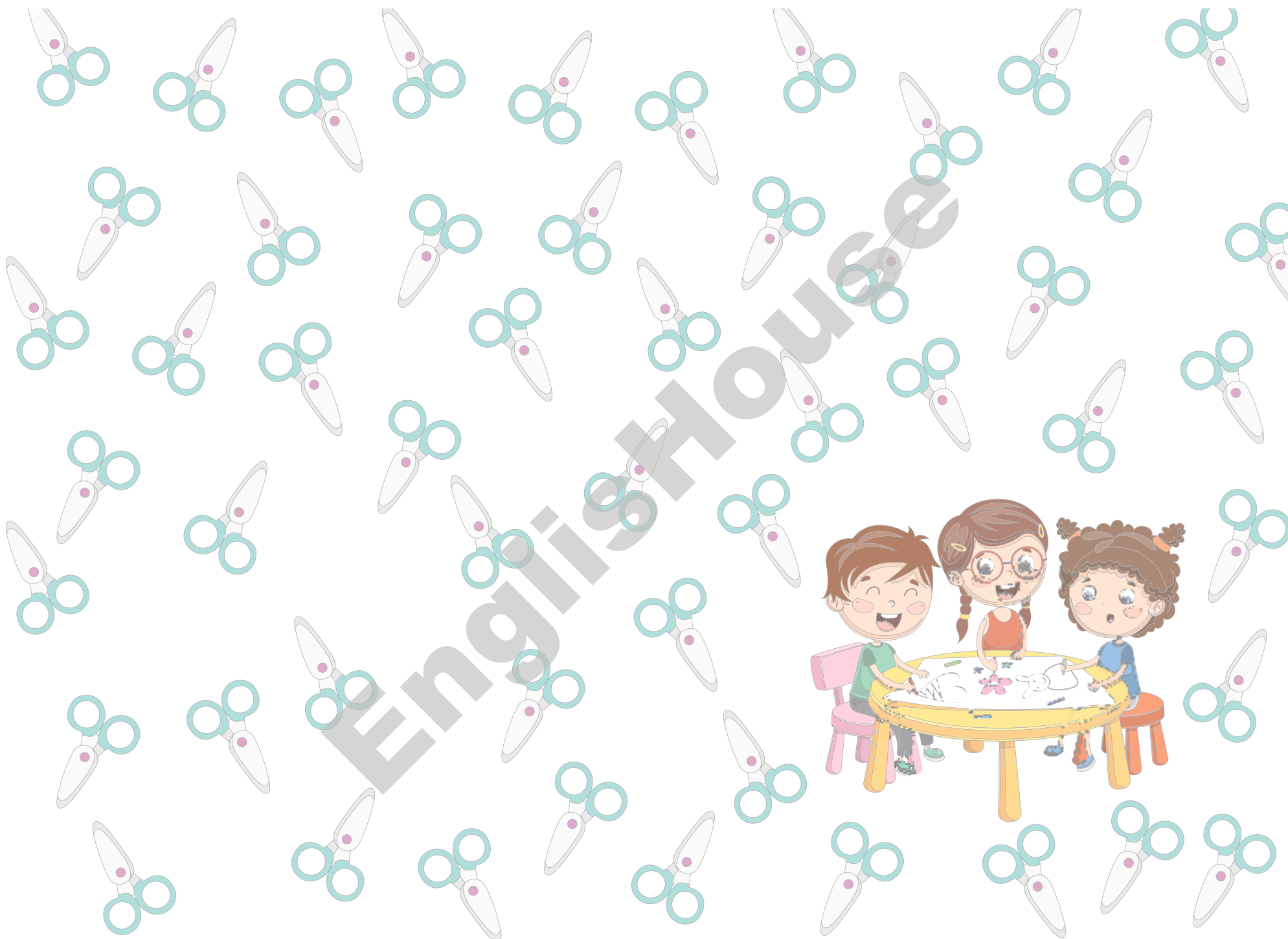



Look and circle.

taste

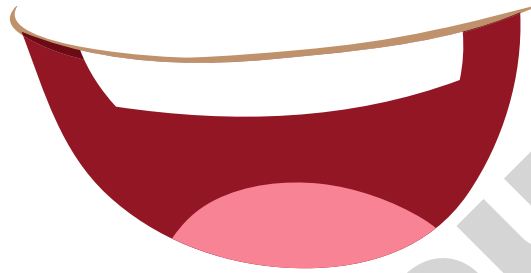

sour

salty

sweet

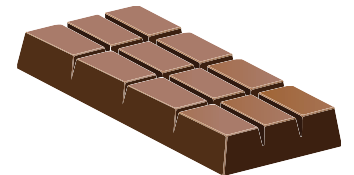

Lesson 11

Look and cross out.

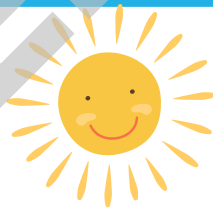
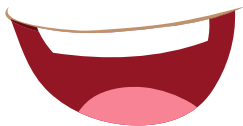
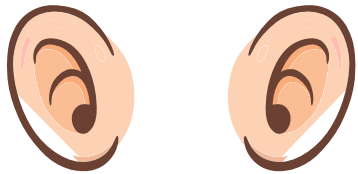
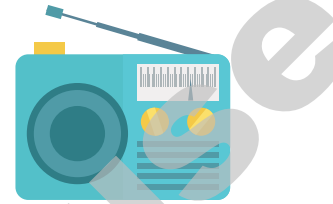
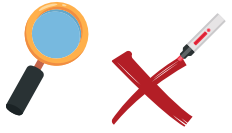

Lesson 12

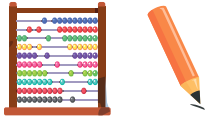

Count and write.



$$\square + \square = \square$$



$$\square + \square = \square$$



$$\square + \square = \square$$



$$\square + \square = \square$$

Lesson 13

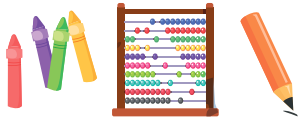

Colour, count and write.

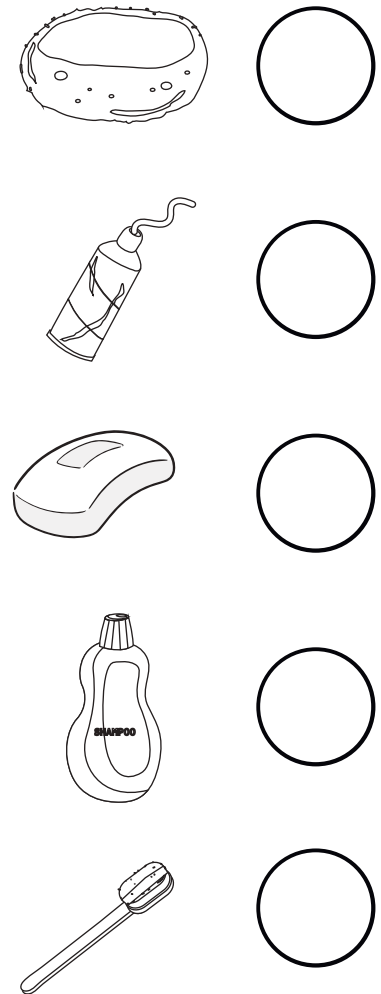

Lesson 14



Look, colour and match.

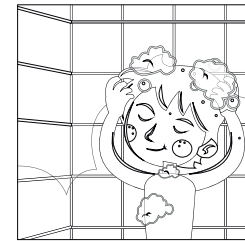
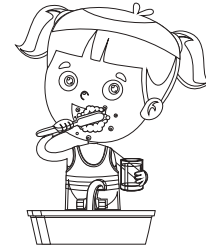
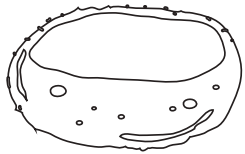





EnglishHouse

Lesson 15

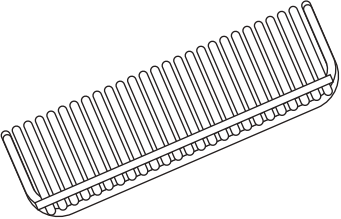
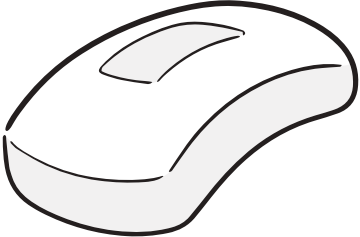
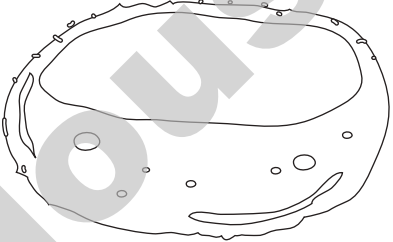

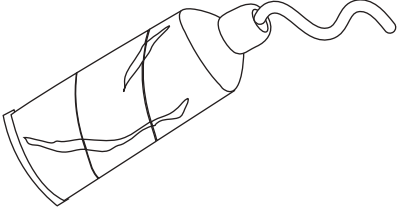
Unscramble, write and colour.

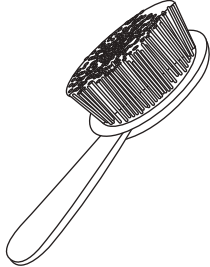
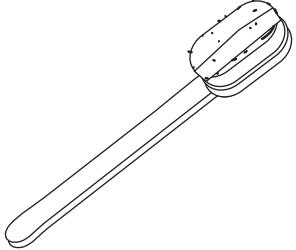
<p>-----</p>  <p>cbmo</p>	<p>-----</p>  <p>opas</p>	<p>-----</p>  <p>gnopes</p>	<p>-----</p>  <p>osahopm</p>
<p>-----</p>  <p>hbtotohrus</p>	<p>-----</p>  <p>lwote</p>	<p>-----</p>  <p>sbrhu</p>	<p>-----</p>  <p>hptotoesta</p>

Lesson 16

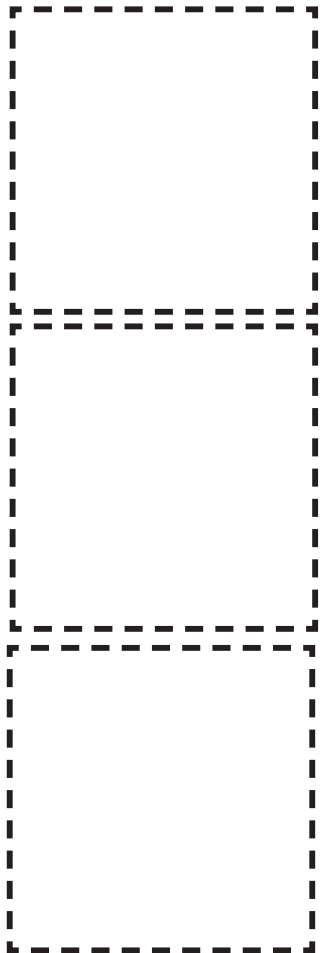

Colour, cut and paste.

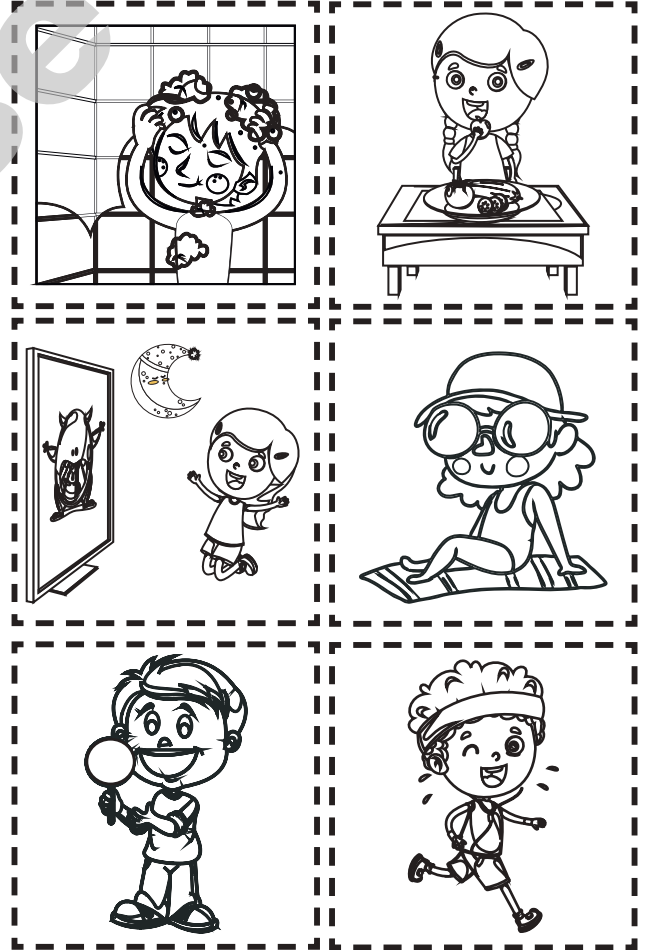

Lesson 17

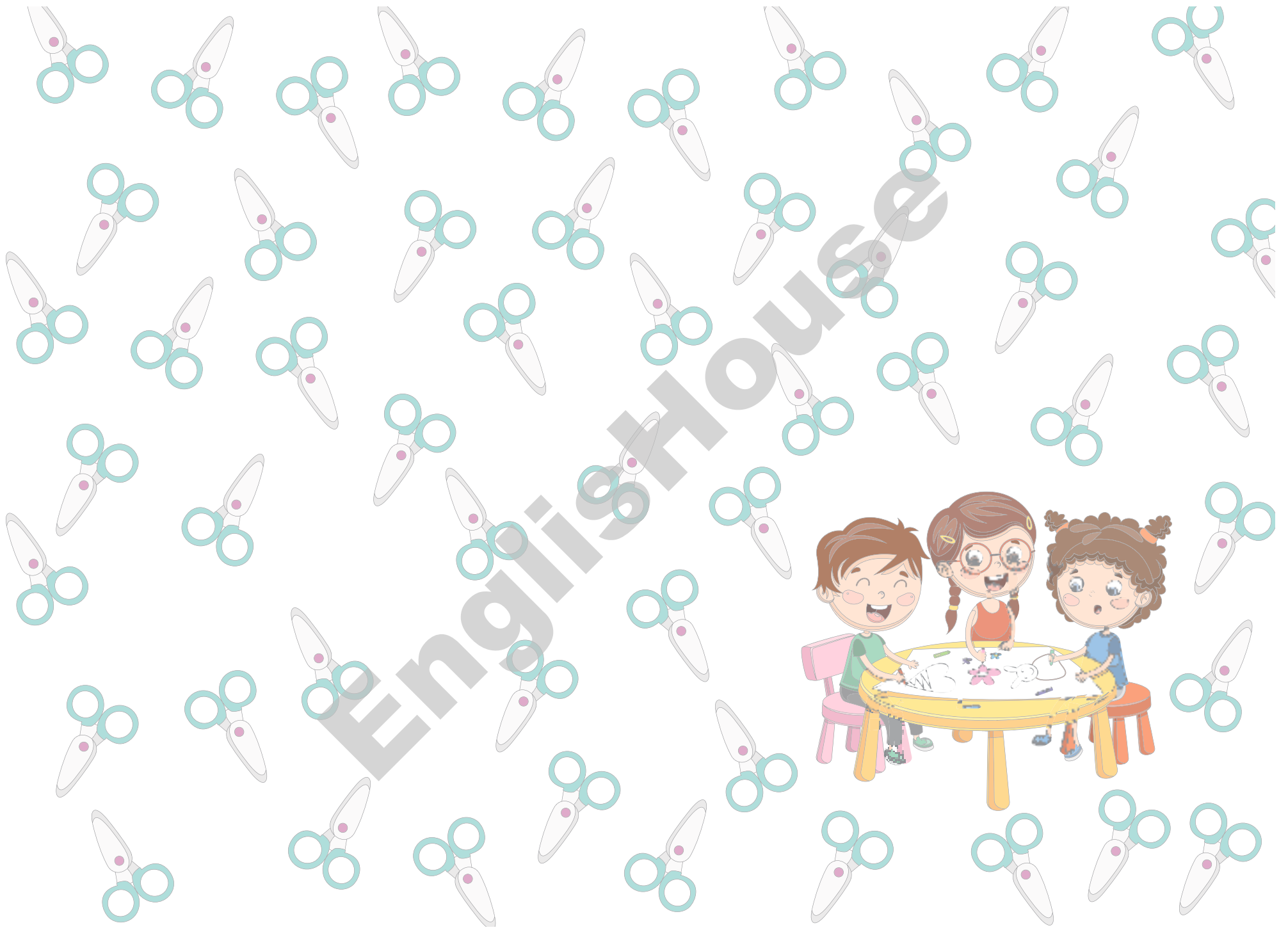



Listen, look and write.

EnglishHour.com















Lesson 18



Listen, trace and colour.



happy



sad

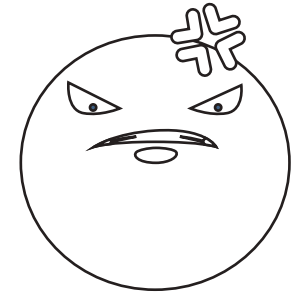

angry



excited



nervous

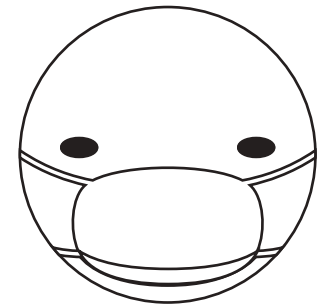

sick

Lesson 19

Colour.

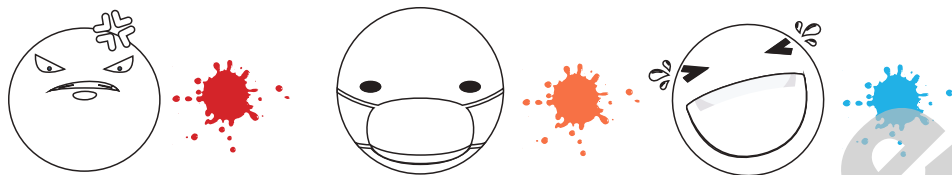

Lesson 20



Listen, circle and colour.

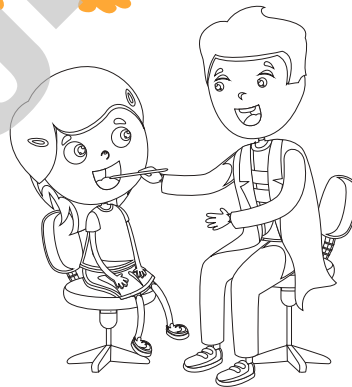

Lesson 21

Match.

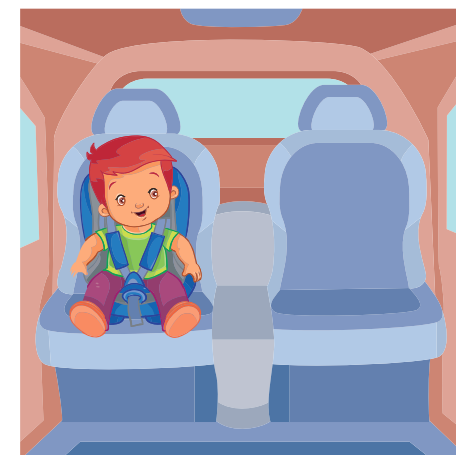
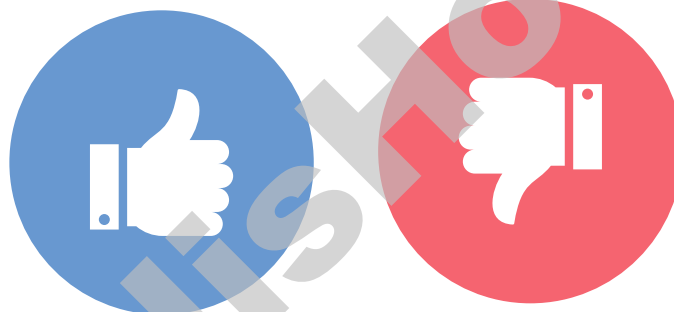

Lesson 22





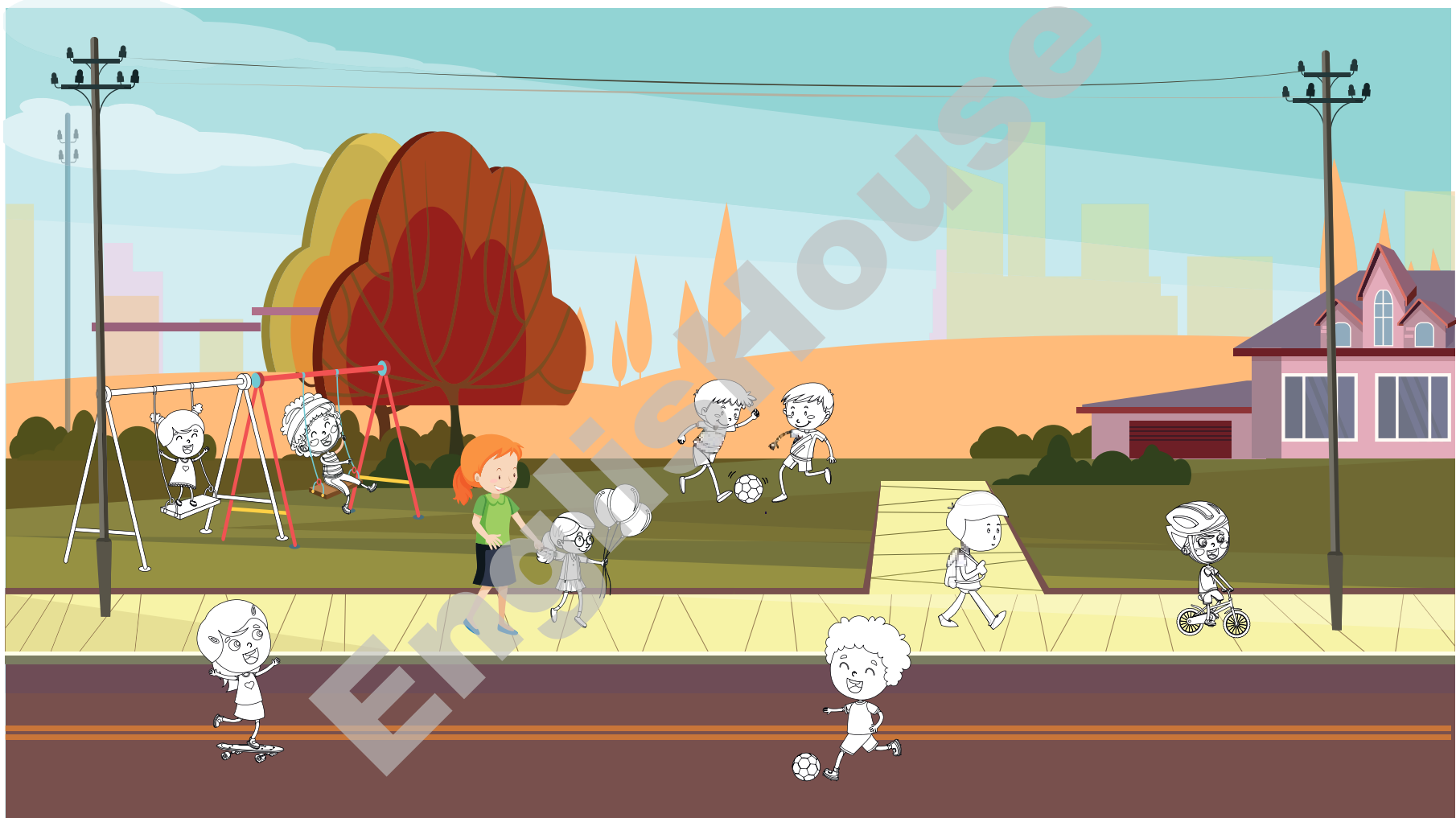

Colour, circle and cross out.



Lesson 23

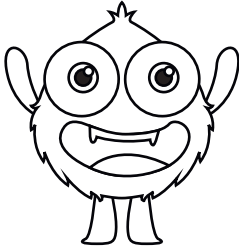
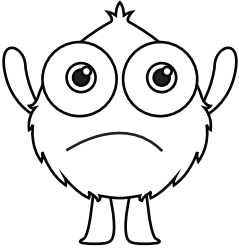

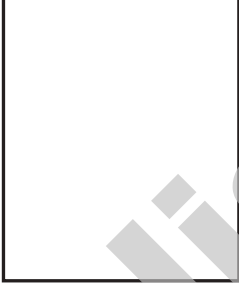
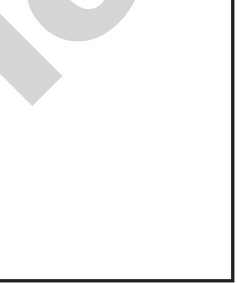
Colour, cut and paste.

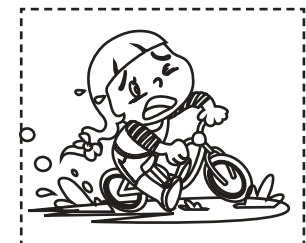
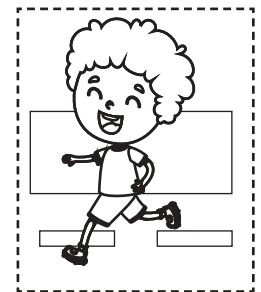
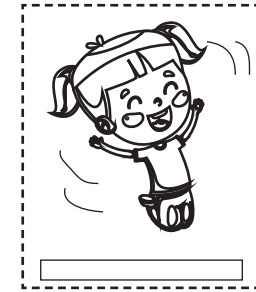
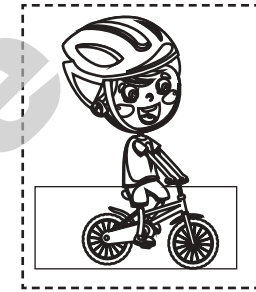

Lesson 24



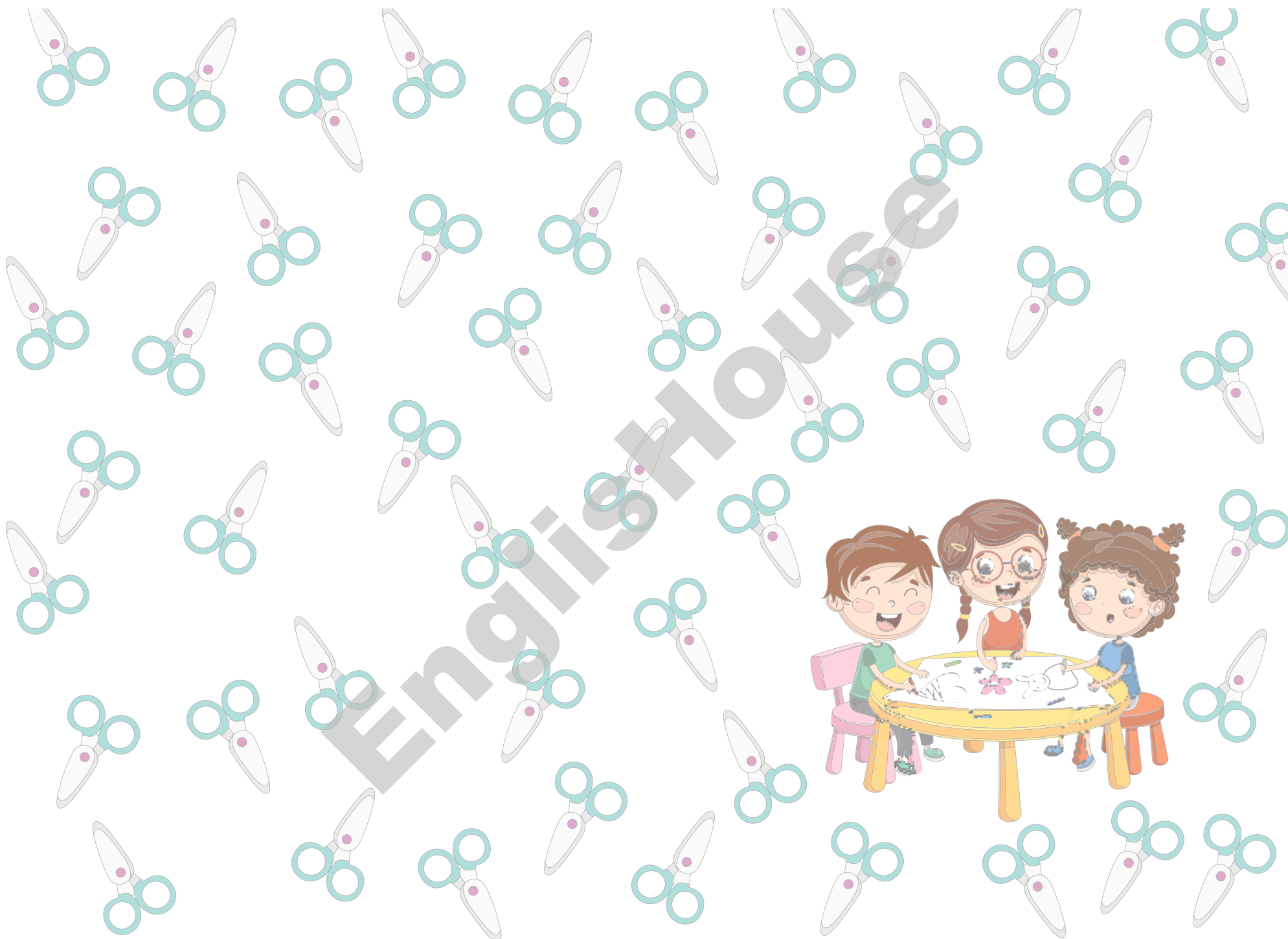

Show What You
Know!



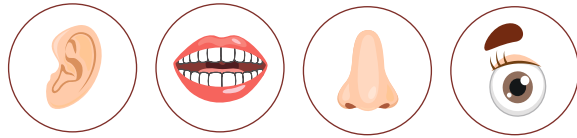

Look and colour.

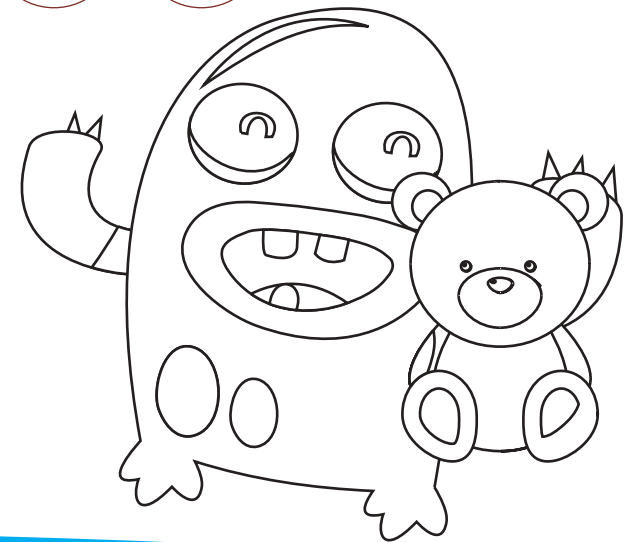
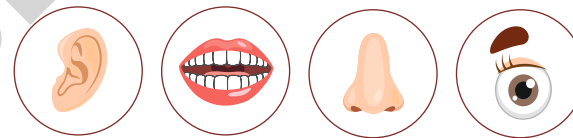
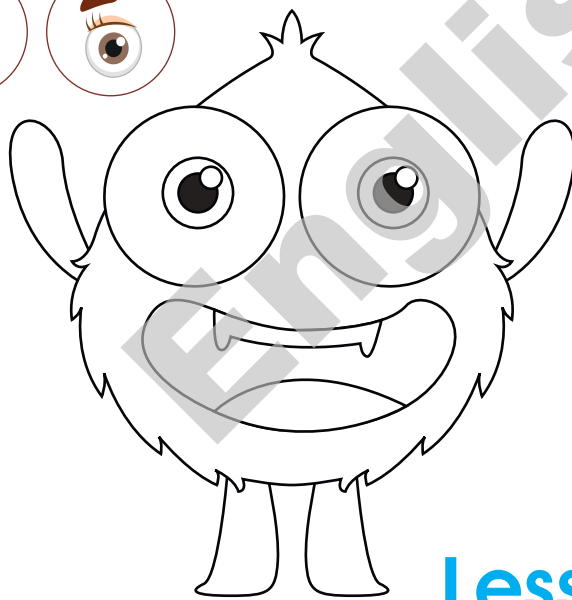
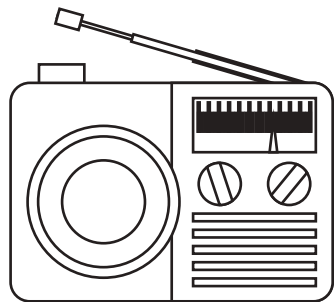
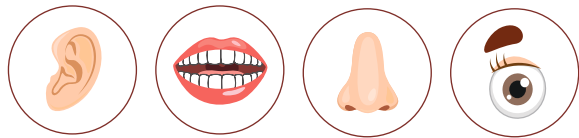
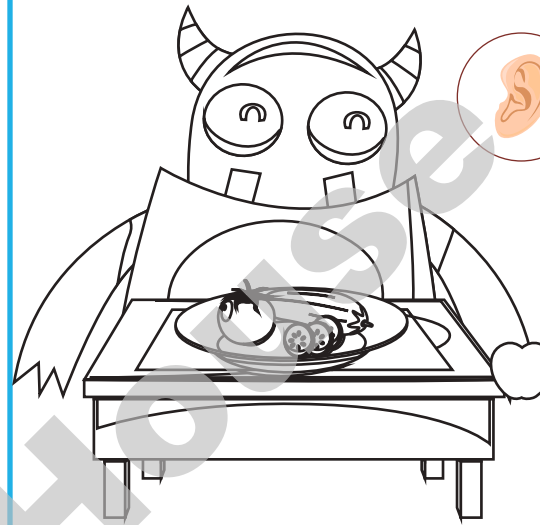
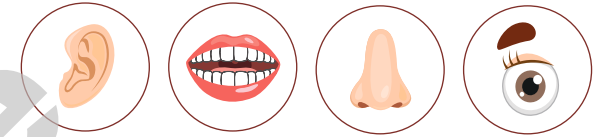

Lesson 25



Trace, cut and paste.

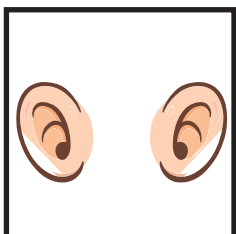
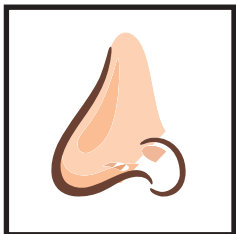
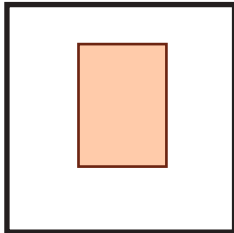
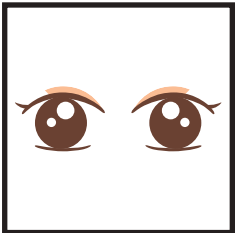
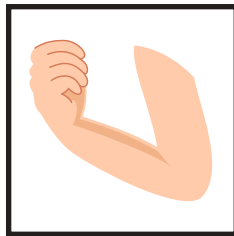

neck	
hand	nose
ears	arm
foot	head
eyes	

Lesson 26



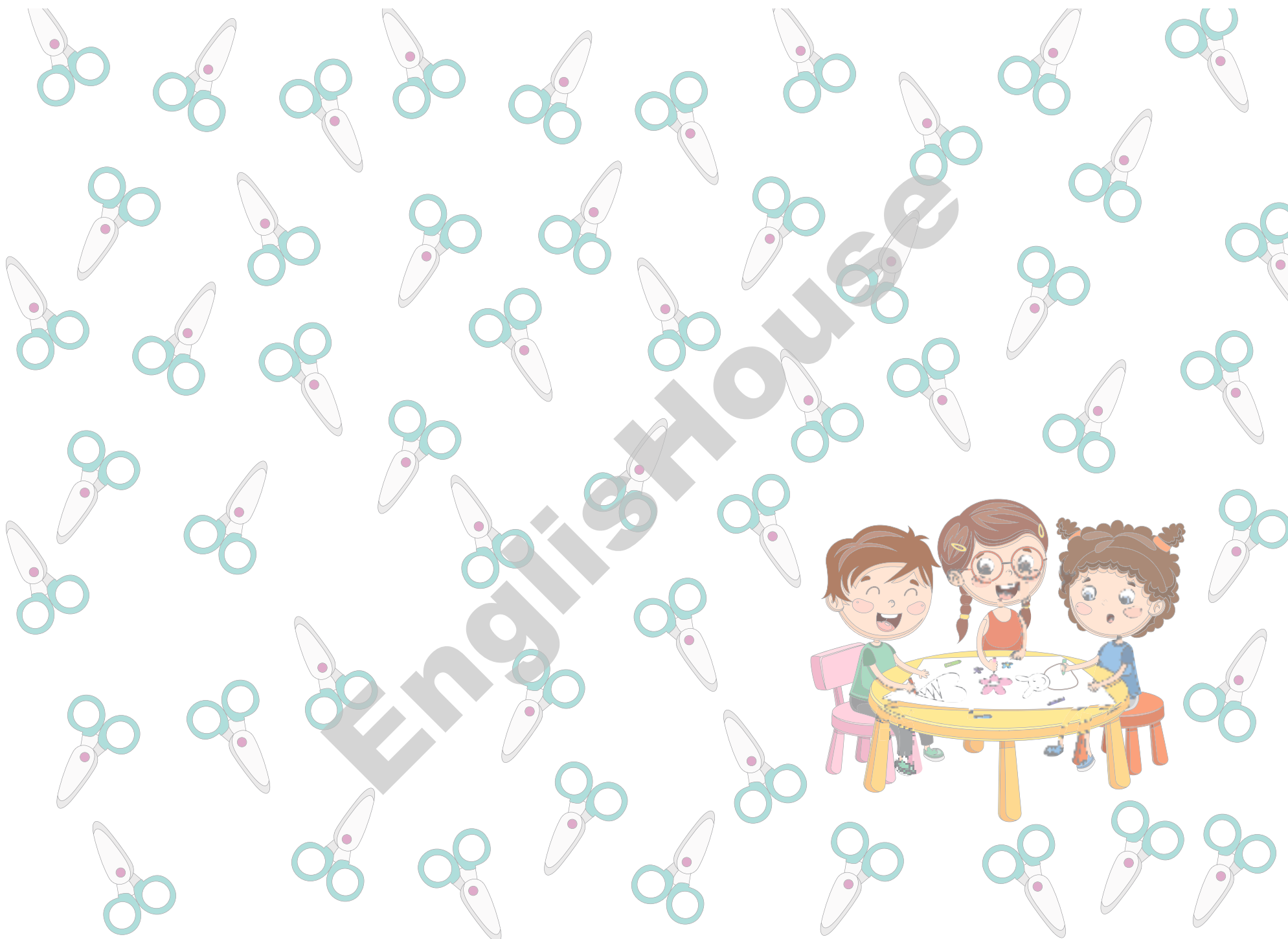

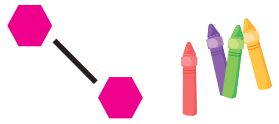

Match and colour.

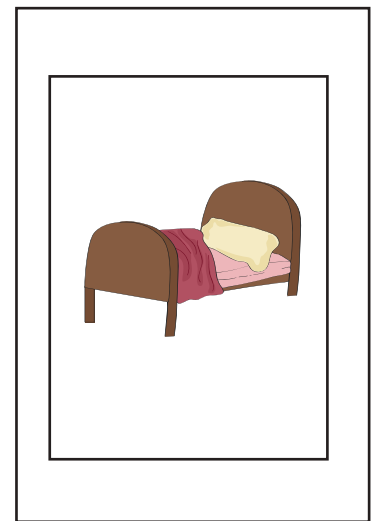
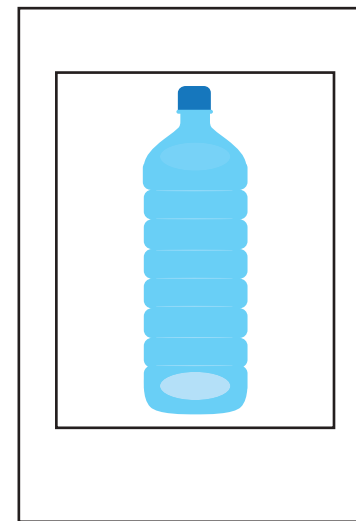
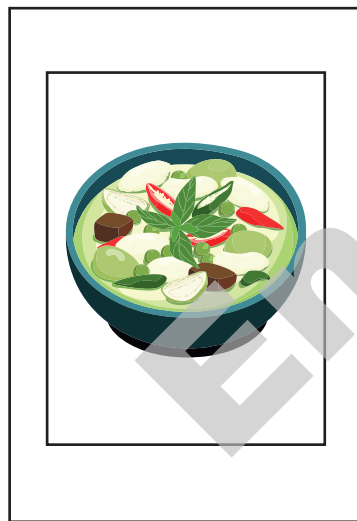
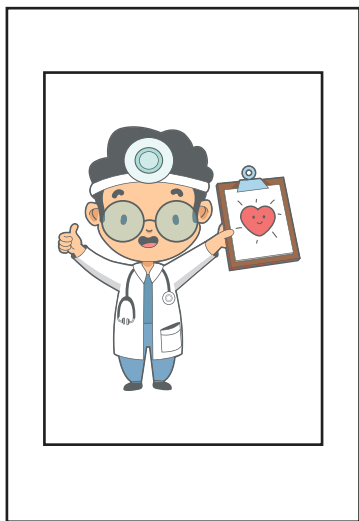
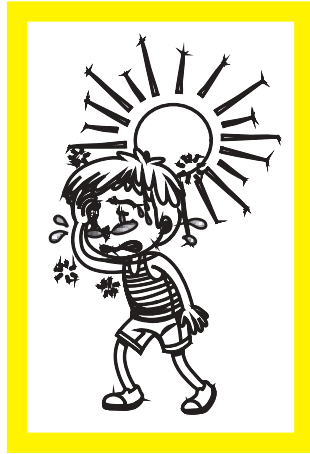
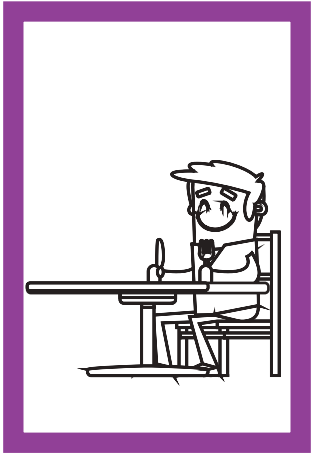

Lesson 27

Unit 3

This is My Family!





Match, trace and colour.

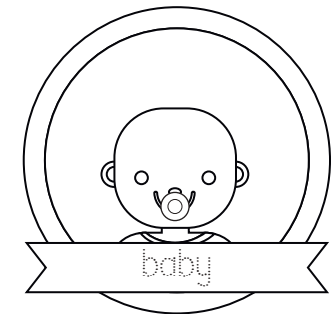
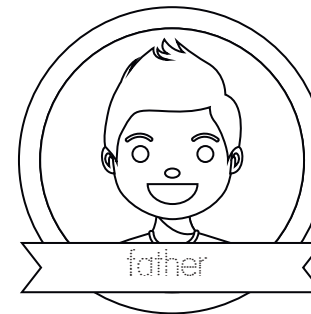
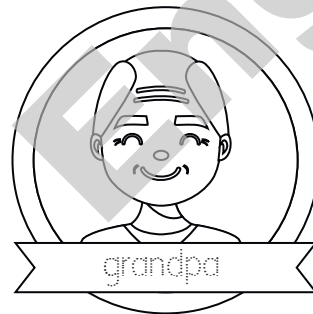
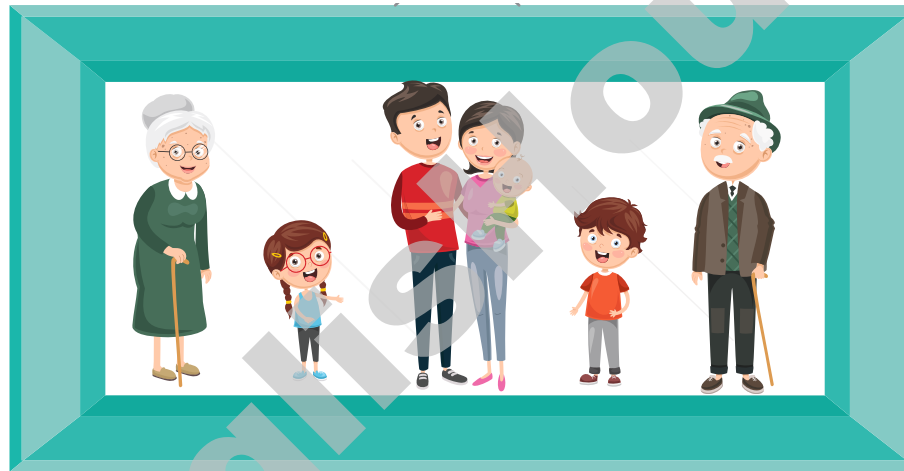
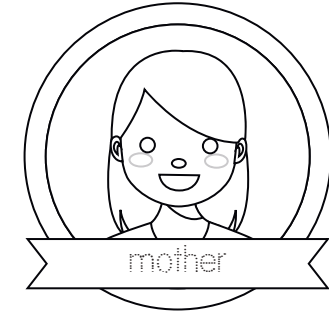
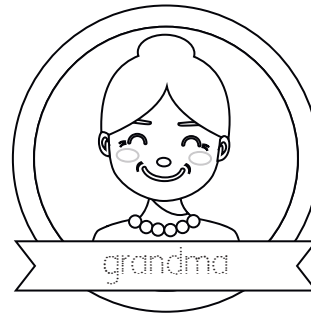
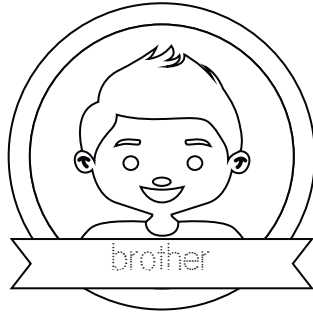

Lesson 01

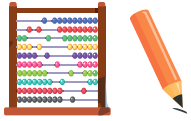

Count and write.



There are _____
monsters in my family.



There are _____
monsters in my family.

Lesson 02

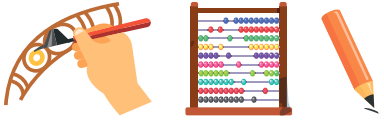

Draw, count and write.

This is my family.



There are _____ people in my family.

Lesson 03



Listen, circle and colour.

1

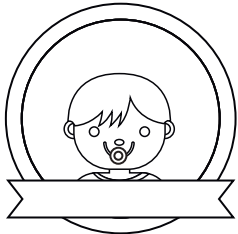
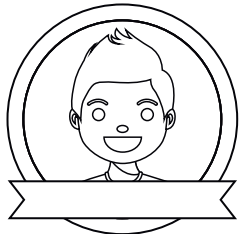
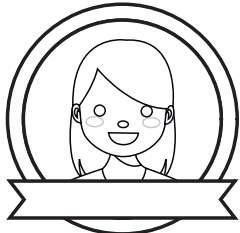

2

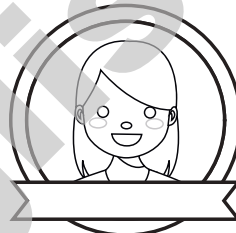

3

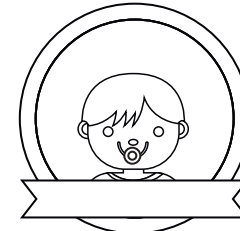
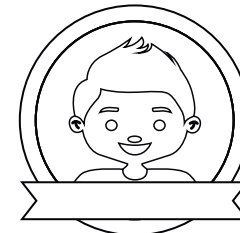
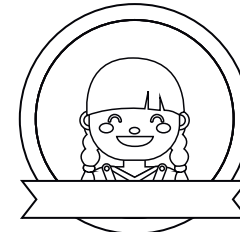

Lesson 04

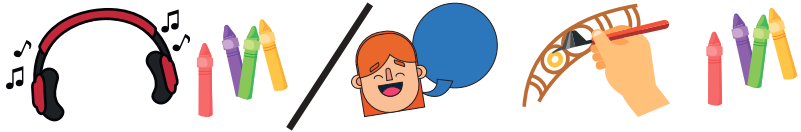

Listen and colour / Ask, draw and colour.

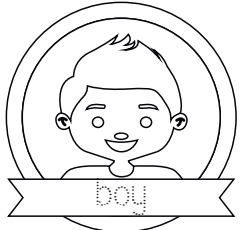

--	--	--	--	--	--	--	--	--	--	--

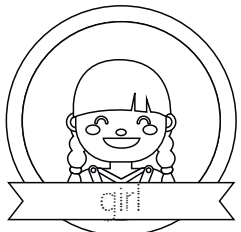

--	--	--	--	--	--	--	--	--	--	--



--	--	--	--	--	--	--	--	--	--	--

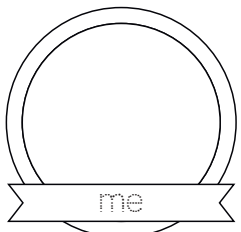

--	--	--	--	--	--	--	--	--	--	--

Lesson 05



Find, circle and colour.

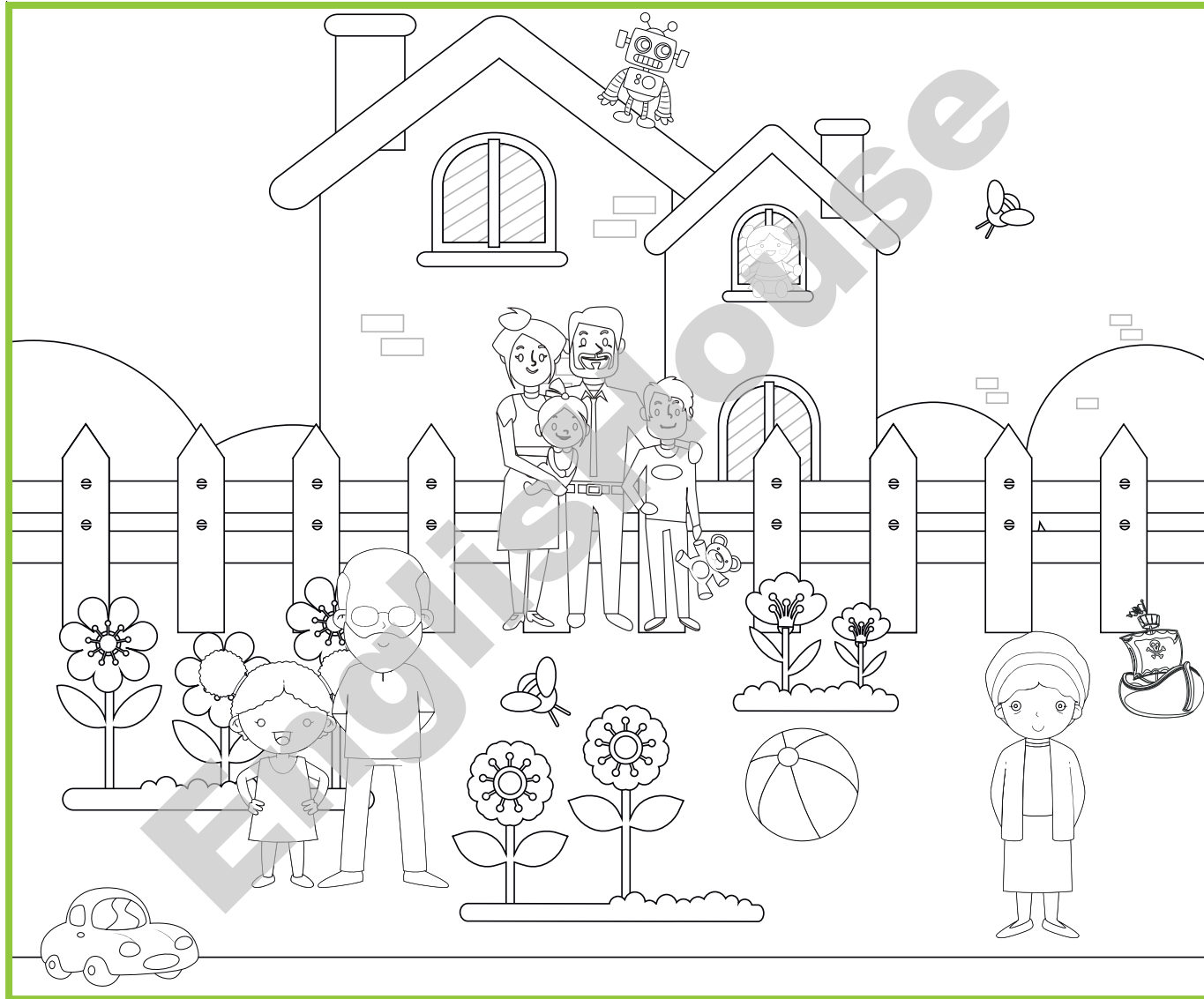

Lesson 06



Look, trace and circle.



long



short



curly



straight



Lesson 07



Trace, read and colour.



long curly brown hair



short straight black hair

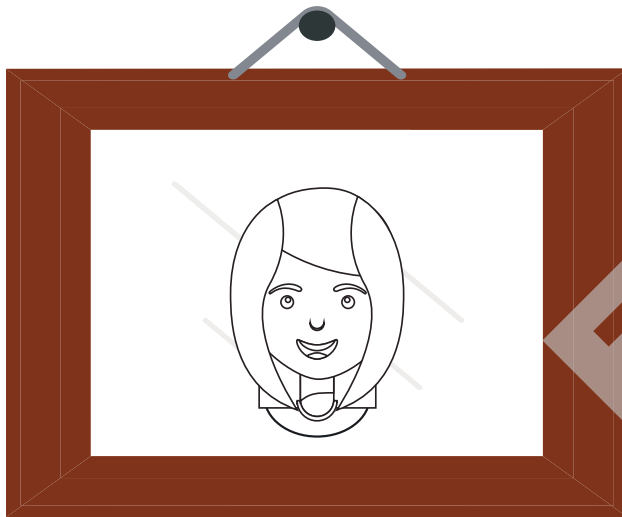

long straight blond hair



short curly red hair

Lesson 08



Cut, listen, paste, draw and colour.

1

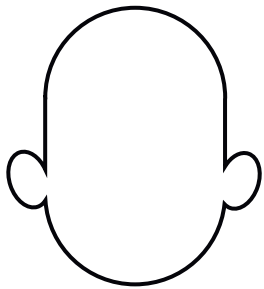

2

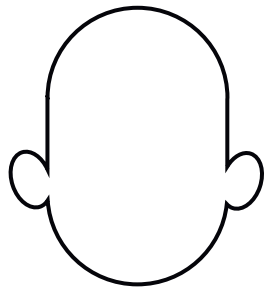

3

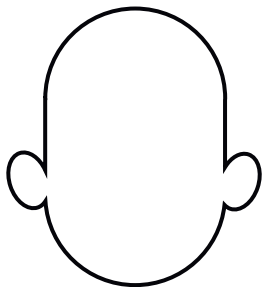

4

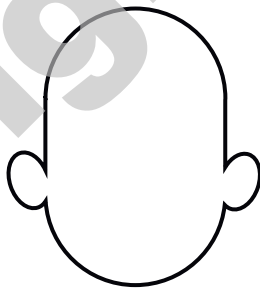

Lesson 09

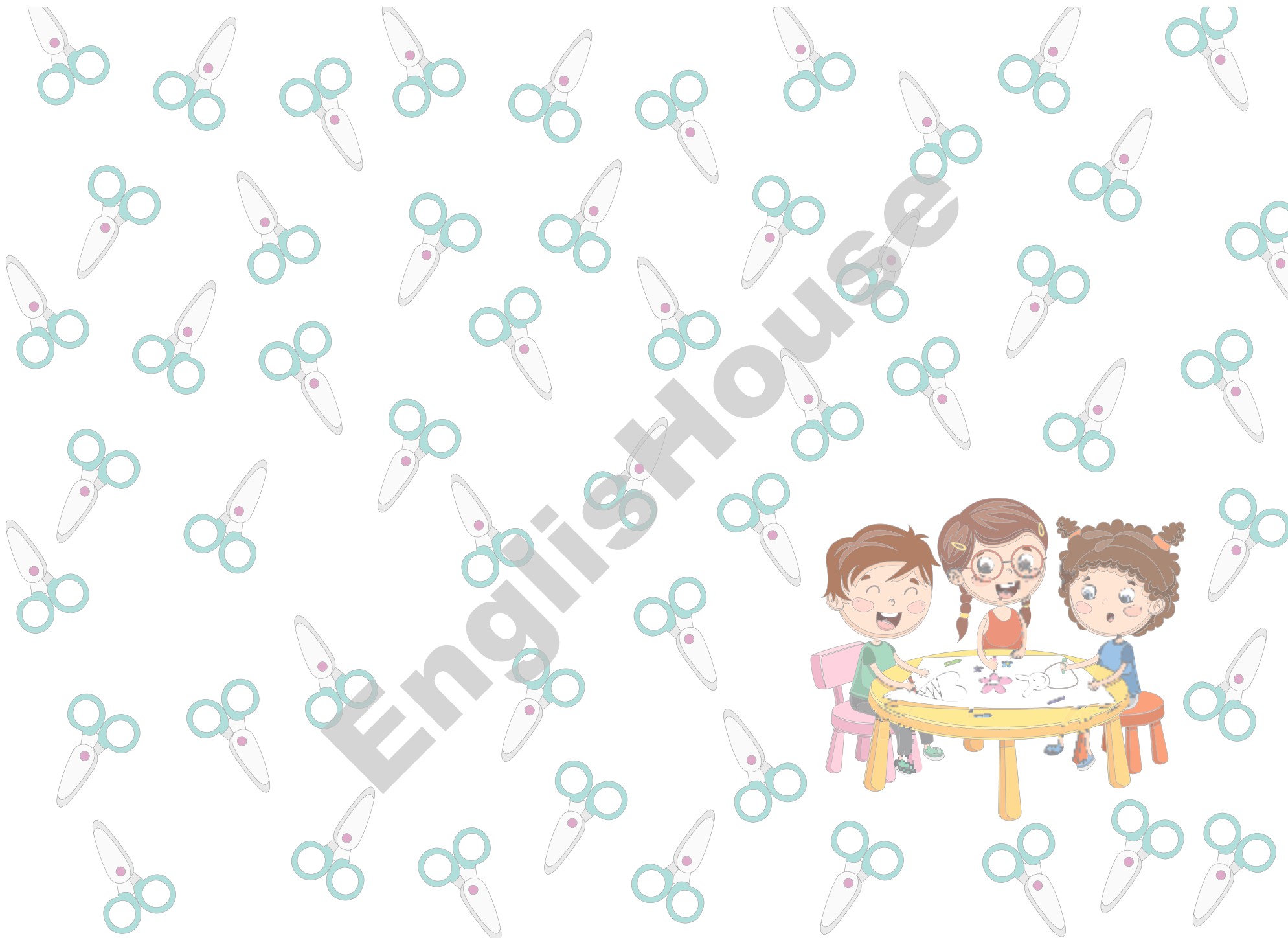



Listen and colour.

Guess who?

Lesson 10



Listen and write.



Lesson 11



Listen, match and draw.

boy

girl

monster

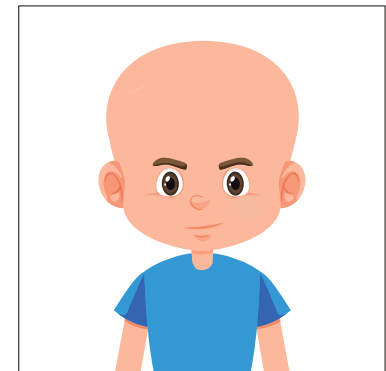
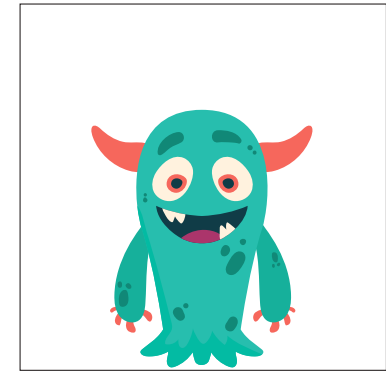
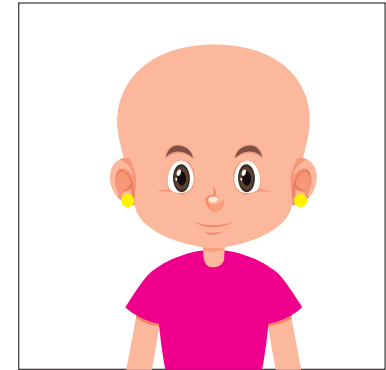

Lesson 13

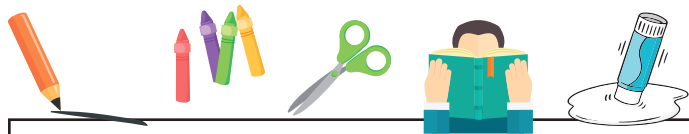

Trace, colour, cut, read and paste.

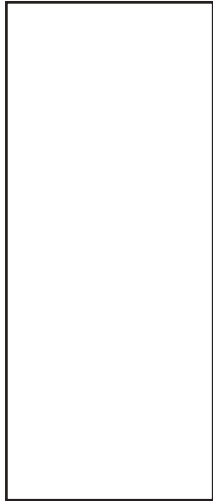

thin



tall

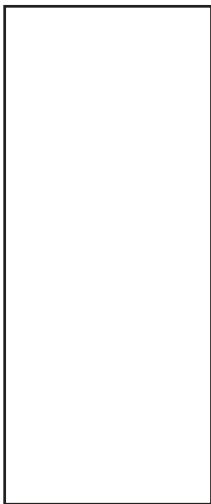

short



tall

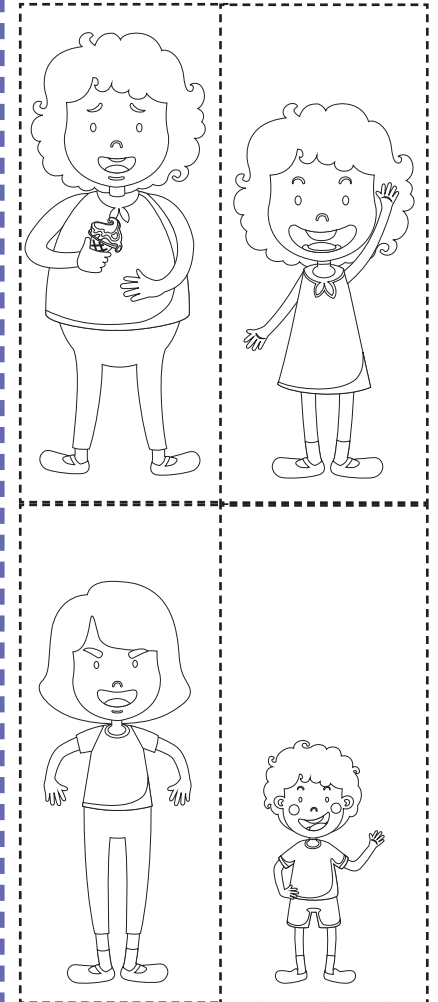

Lesson 14

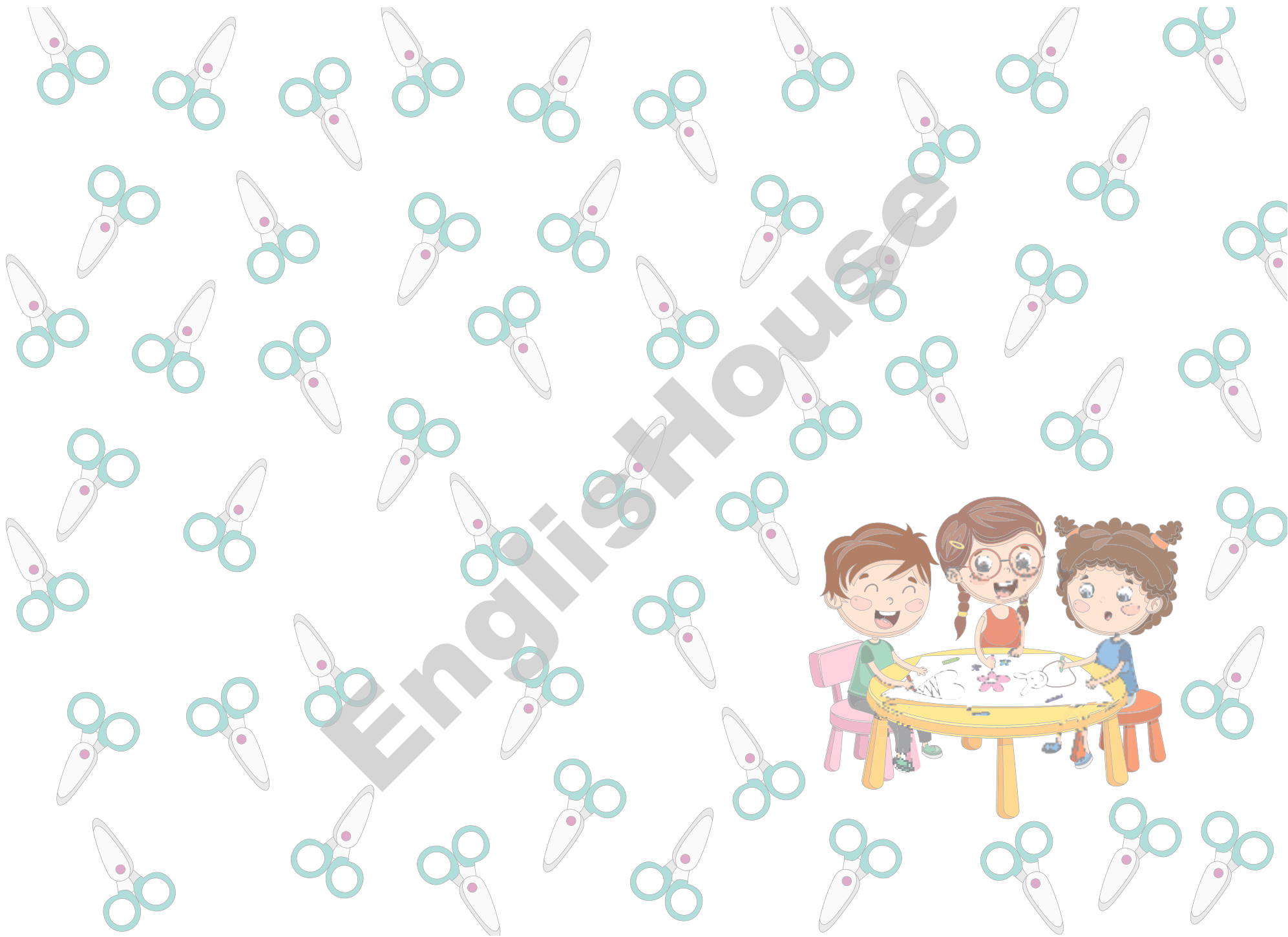



Look, listen and colour.

1
● short

● tall

2
● thin

● fat

① ②



taller

① ②



shorter

① ②



fatter

① ②



thinner

Lesson 15



Listen, look and circle.

1



2



3



4



Lesson 16



Look, listen and colour.



Lesson 17



Trace, circle and colour.

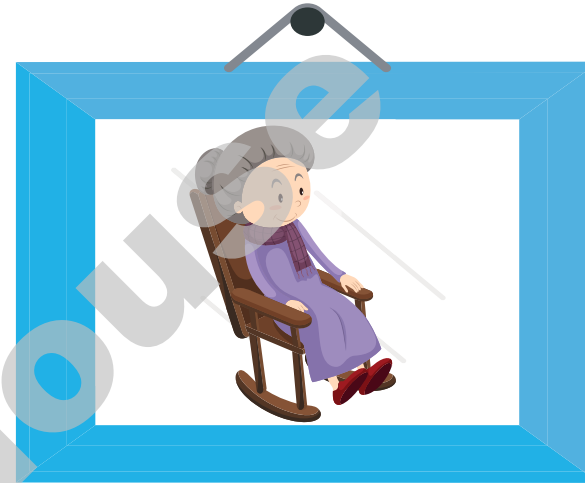

young

old

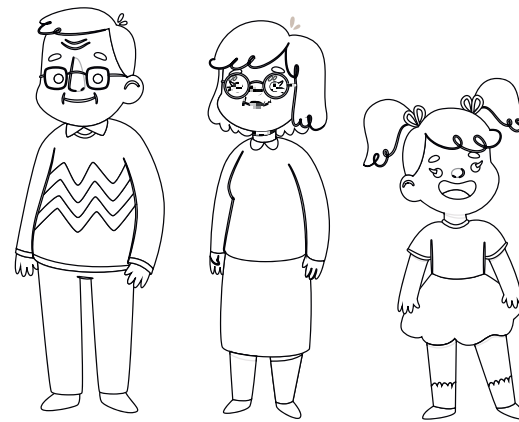
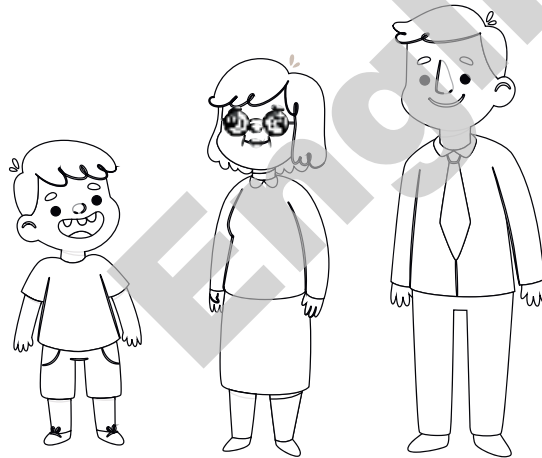

Lesson 18



Colour, cut, listen and paste.

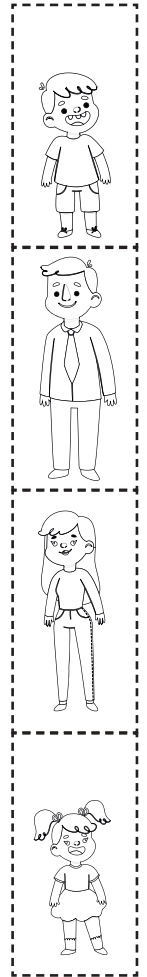
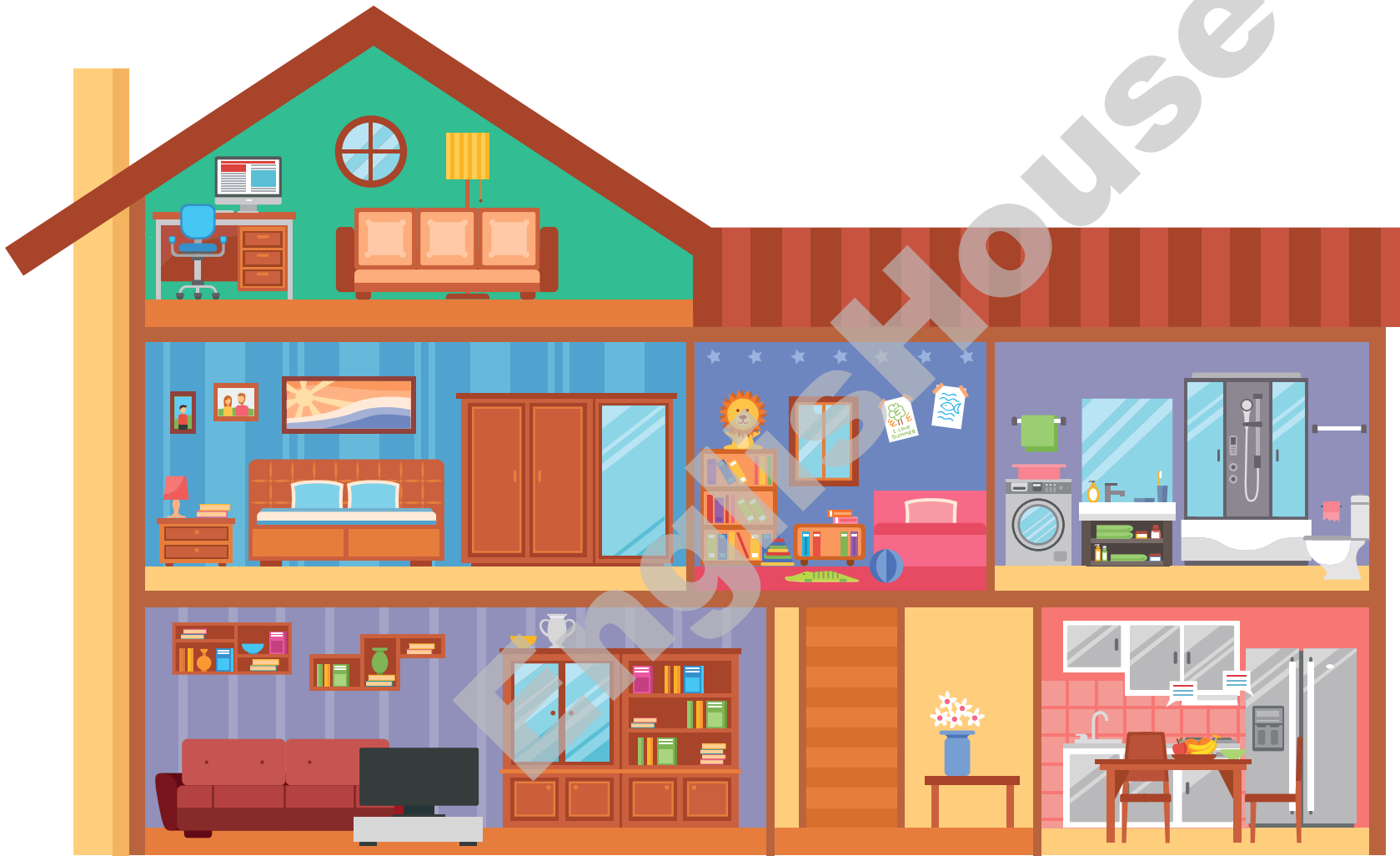

Lesson 19

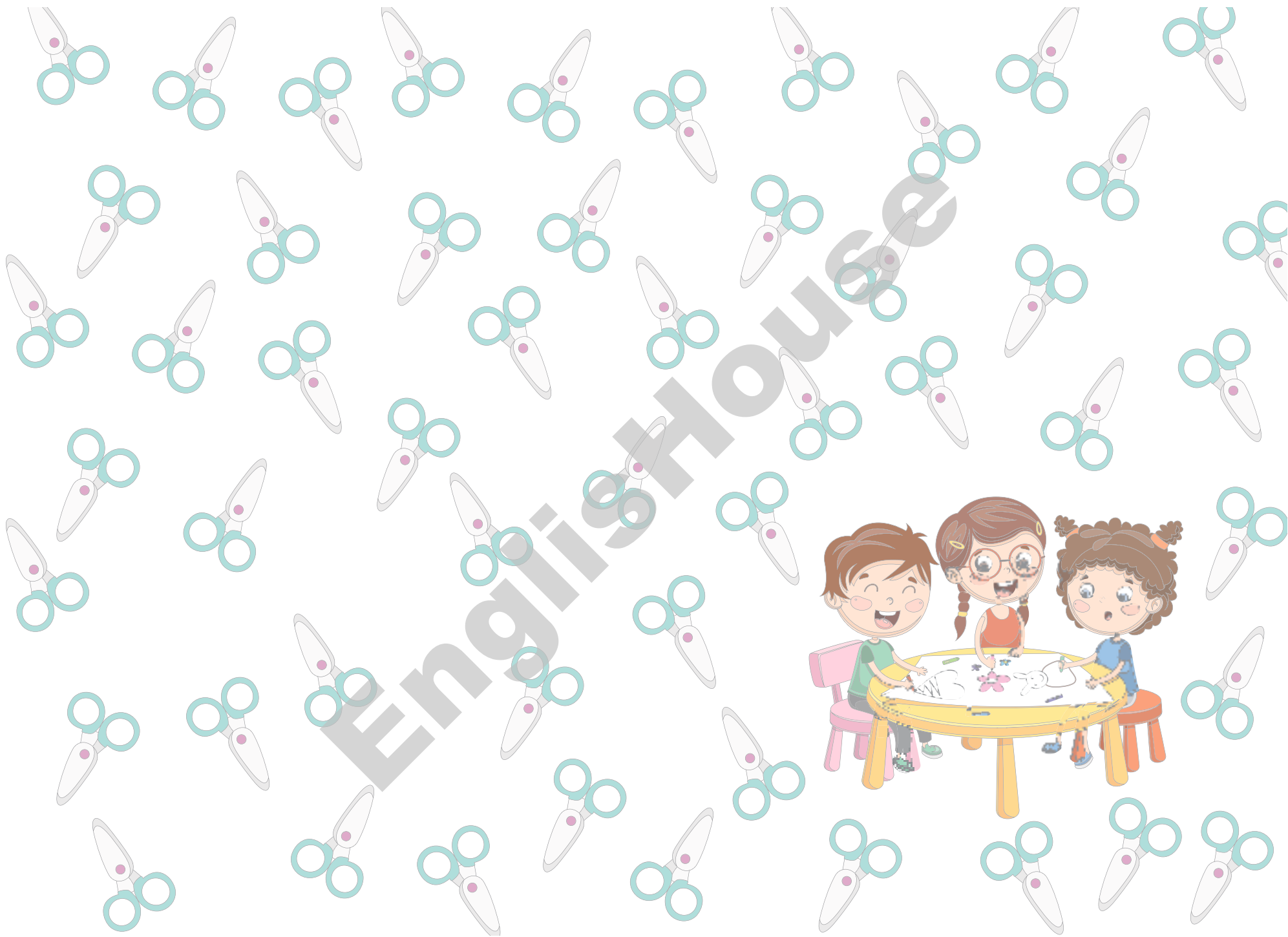



b - e - d - r - o - o - m



Colour and write.

k - i - t - c - h - e - n

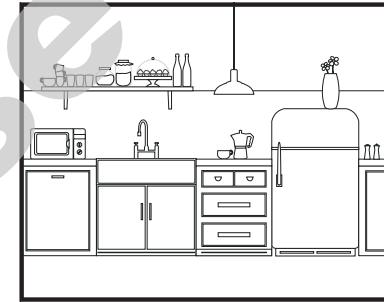

l - i - v - i - n - g - r - o - o - m

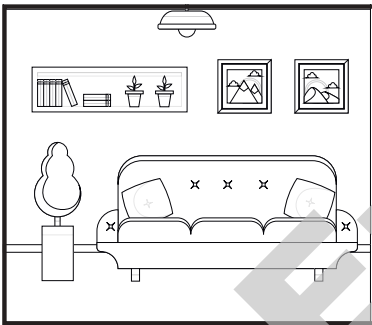

b - a - t - h - r - o - o - m

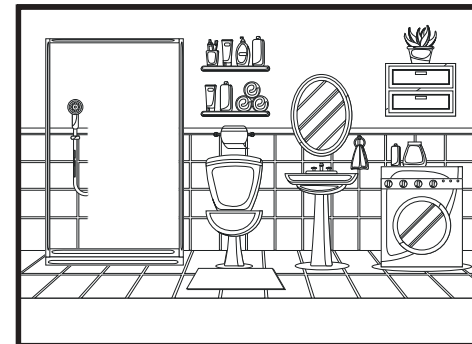

Lesson 20



Trace and colour.

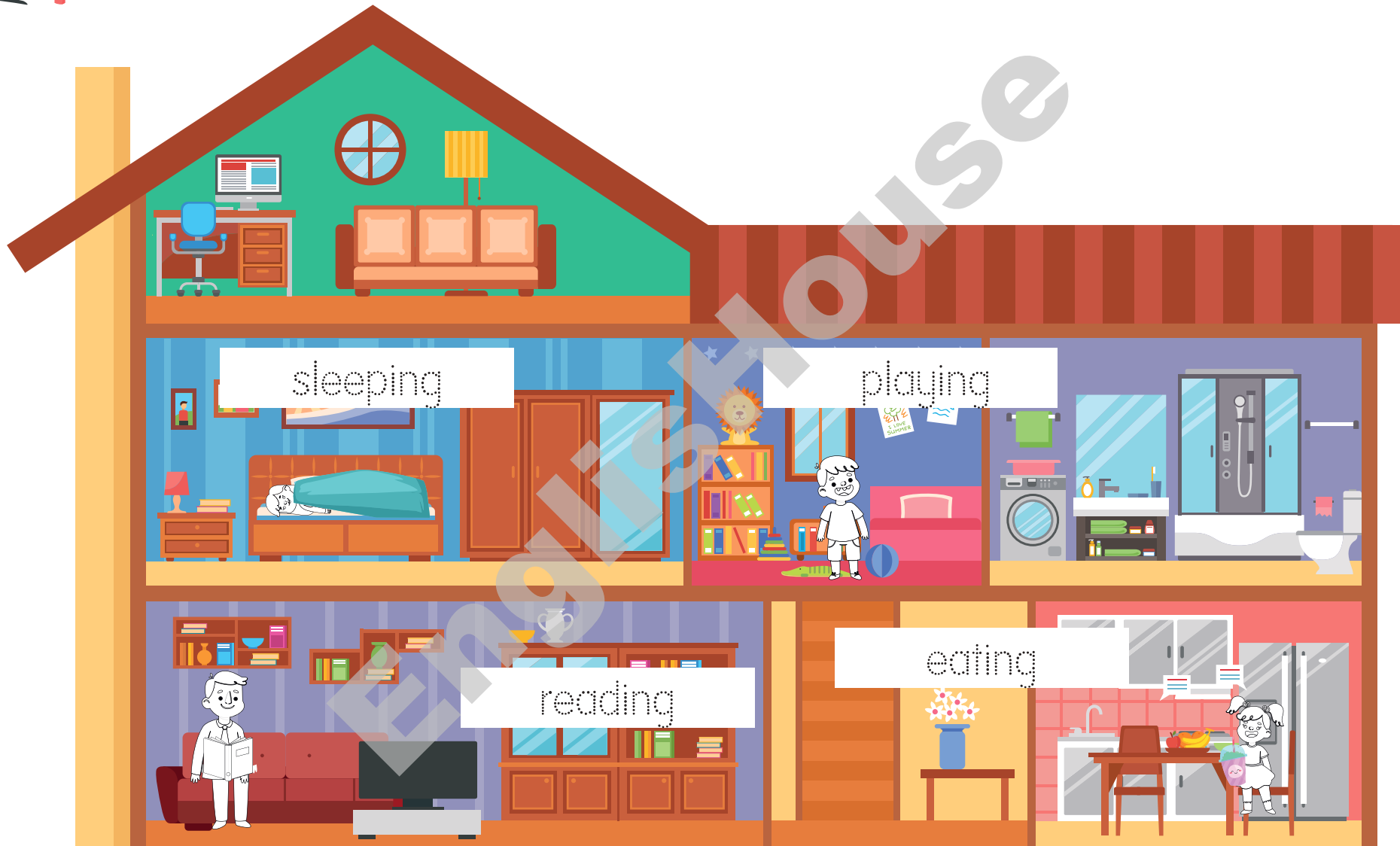

Lesson 21



Trace, colour, read and write.



The sofa is in the _____.

The fridge is in the _____.

The bathtub is in the _____.

The bed is in the _____.

The table is in the _____.

Lesson 22

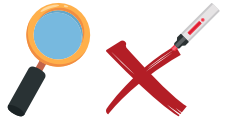

Look and cross out.

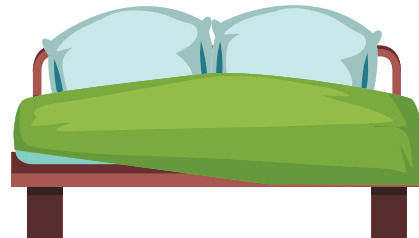
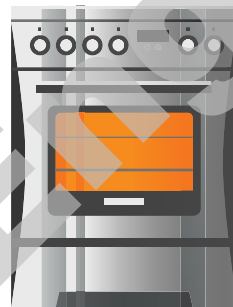
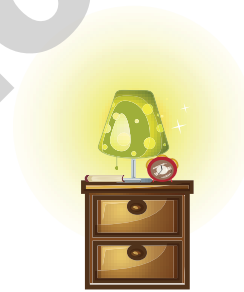
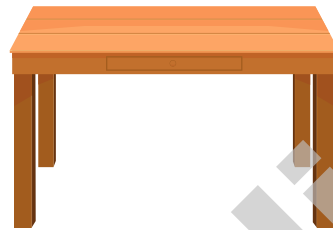
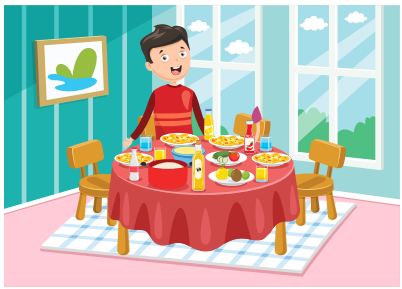
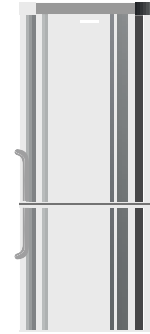

Lesson 23



Listen and circle.

1

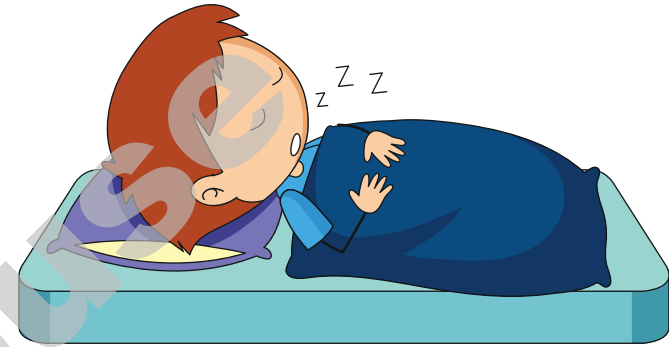

2



3

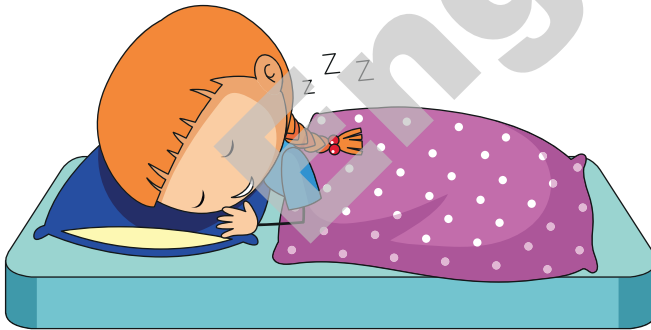

Lesson 24

Show What You
Know!

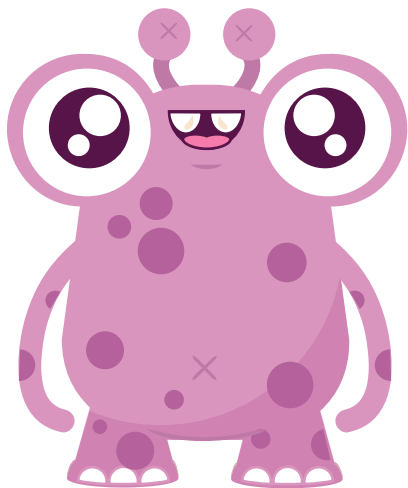



Listen and colour.



Yes

No



Yes

No



Yes

No

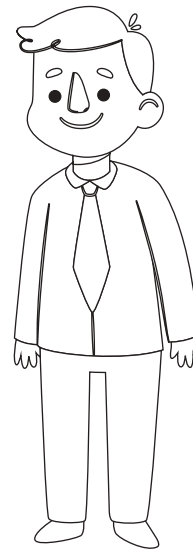

Yes

No

Lesson 25



Trace, read, match and colour.

bathroom

bedroom

dining
room

livingroom

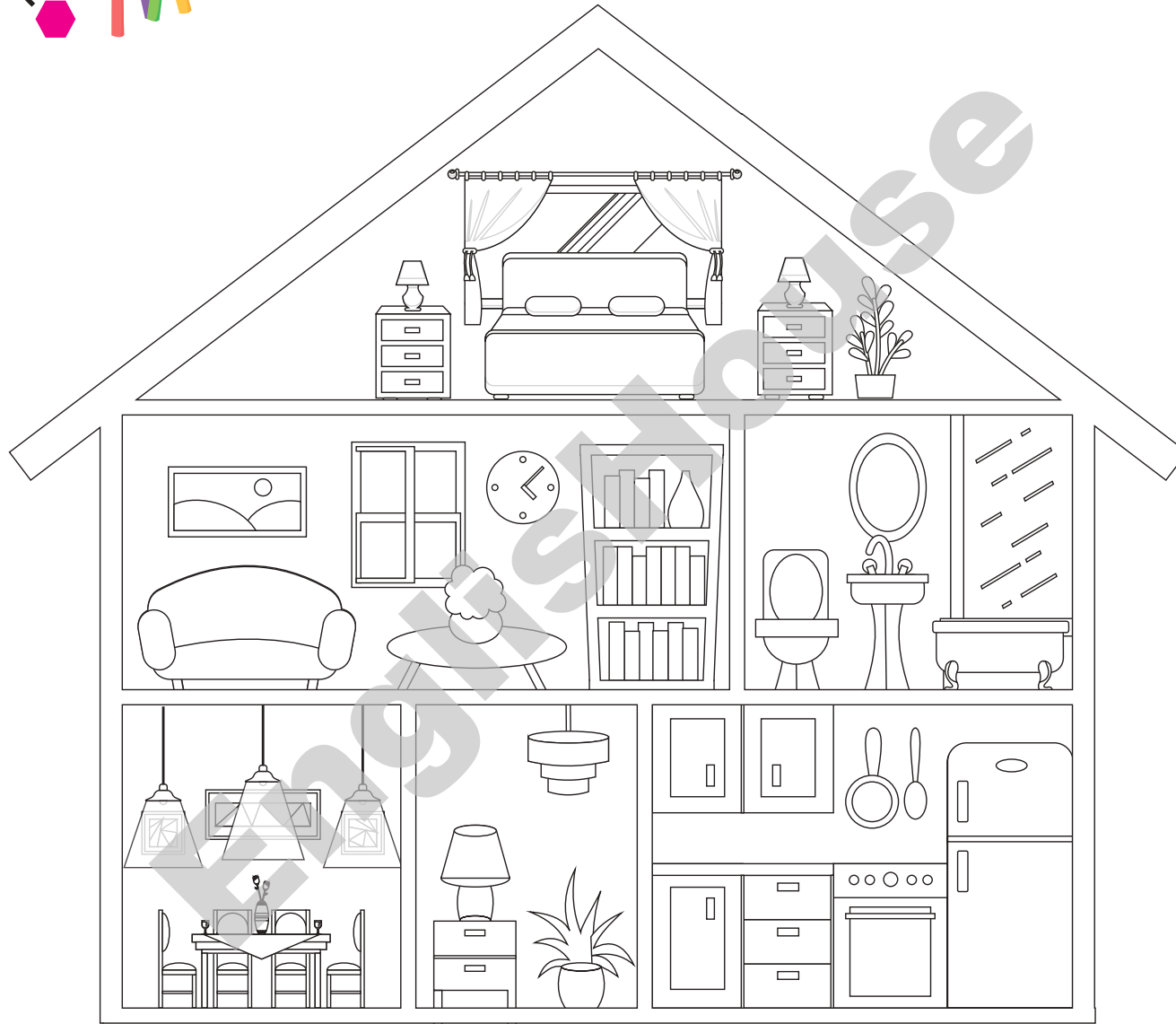







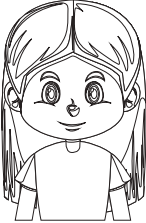

kitchen

Lesson 26



Cut, read, paste and colour.





			
			
			
			

long and curly

short and curly

long and straight

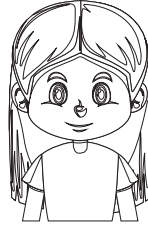
short and straight



Lesson 27

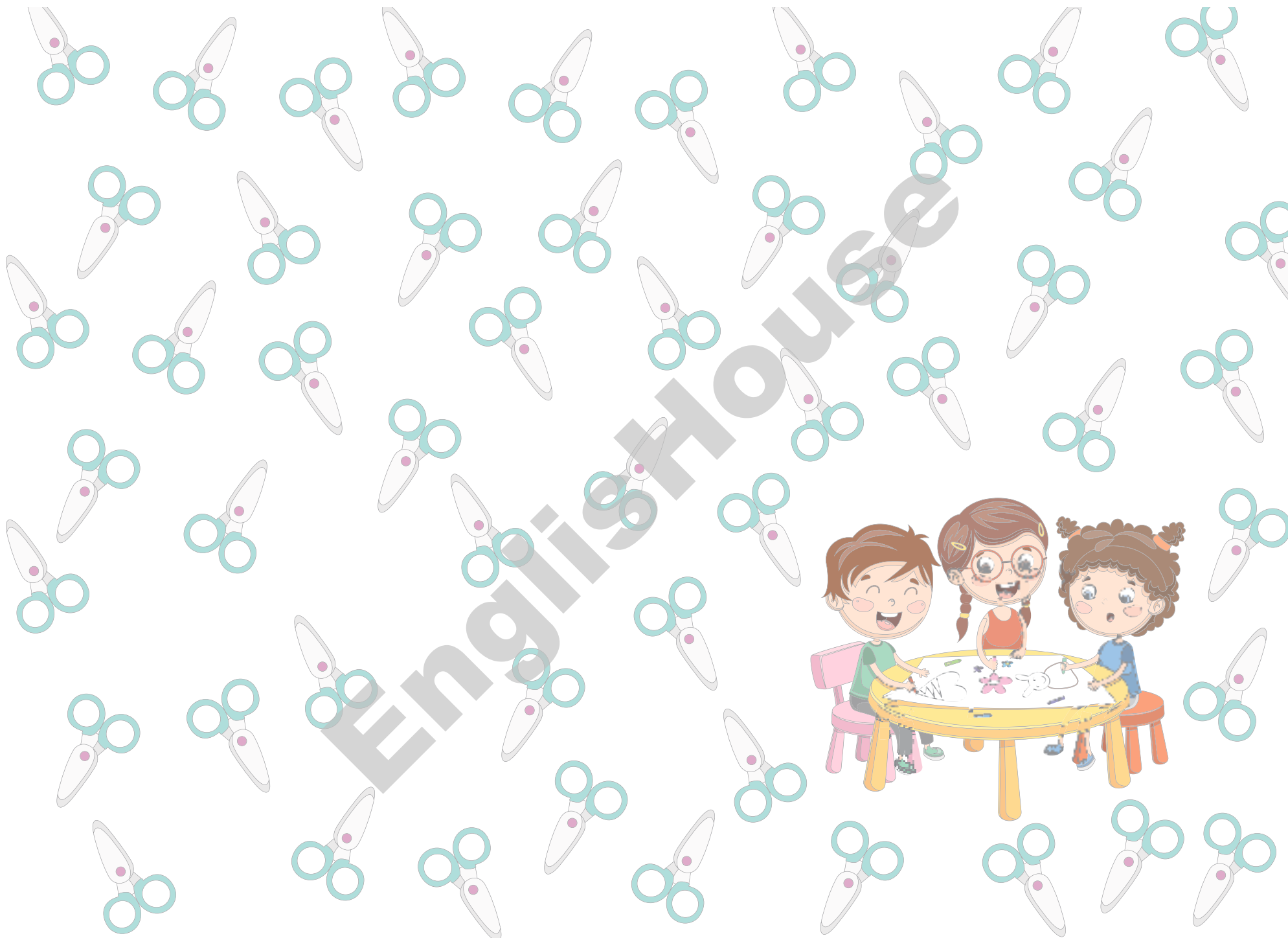

Unit 4

Yummy, Yummy!





Trace, colour and play.

Fruit Bingo



apple



orange

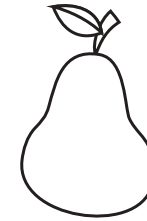

pear



mango



pineapple

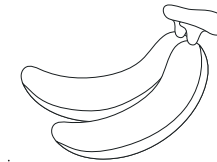

banana

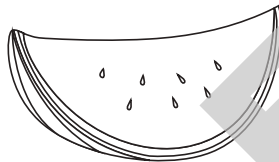

watermelon

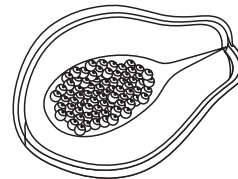

papaya

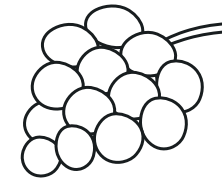

grapes

Lesson 01



Listen and colour.

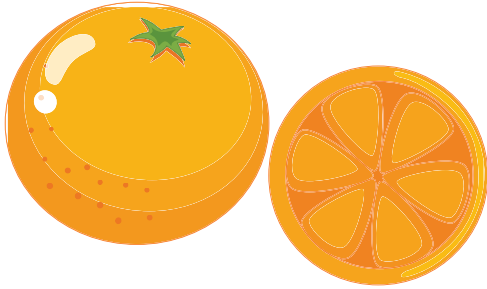

Yes

No



Yes

No



Yes

No

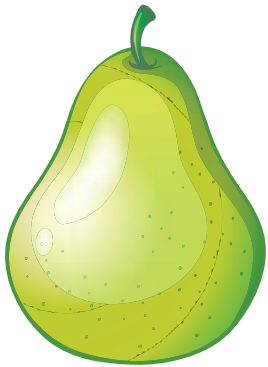

Yes

No

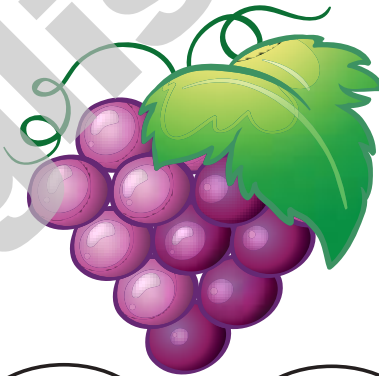

Yes

No

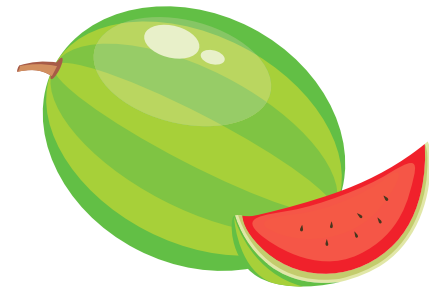

Yes

No

Lesson 02

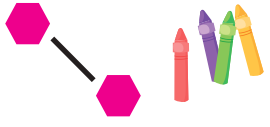

Match and colour.

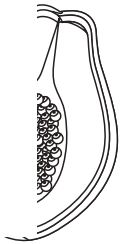

EnglishHouse

Lesson 03



Count, listen and colour.



Lesson 04



Read, draw and colour.

Draw 5



Draw 3

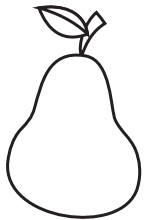

Draw 8



EnglishHouse

Lesson 05



Count, write and colour.

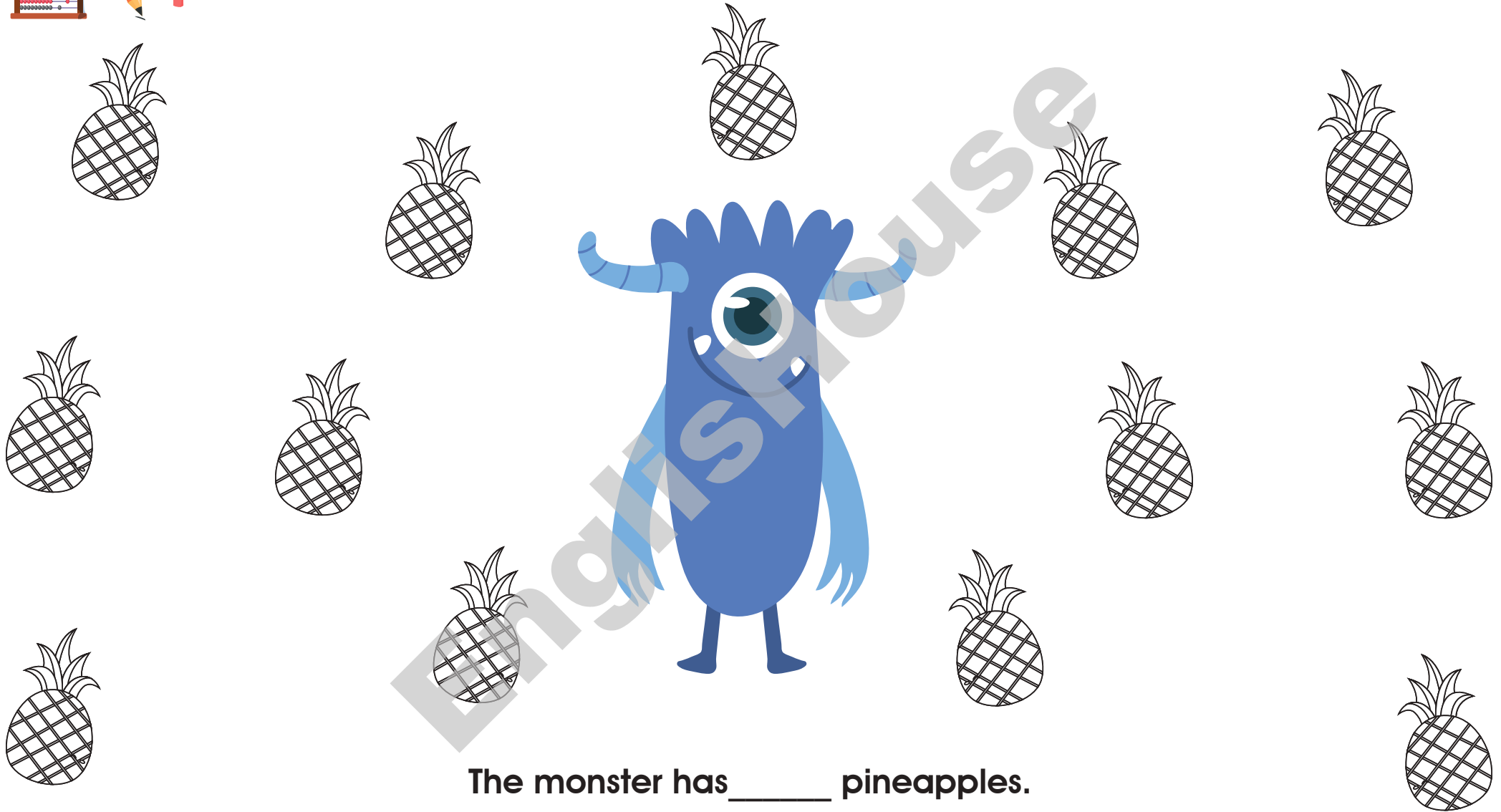

The monster has _____ pineapples.

Lesson 06



Listen, point and colour.

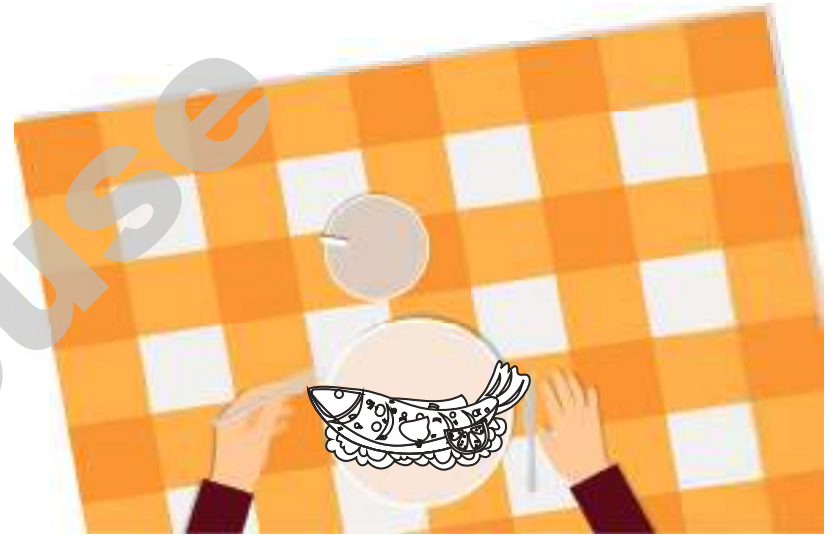
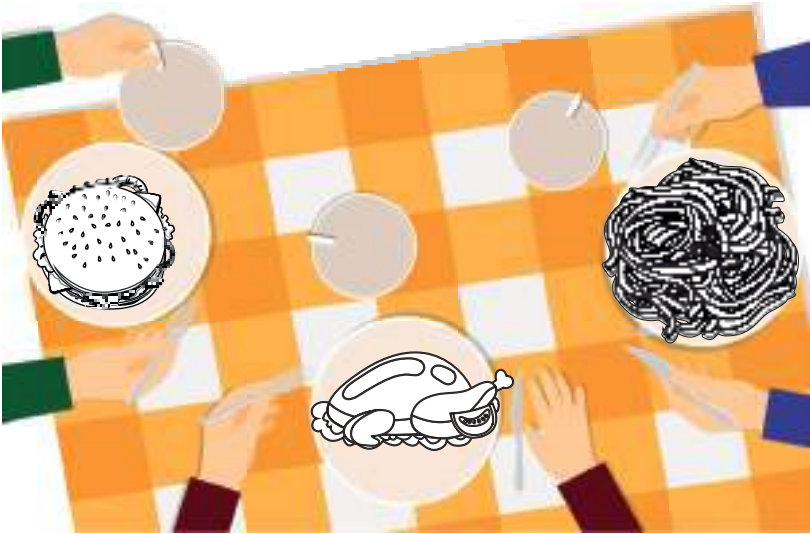

Lesson 07

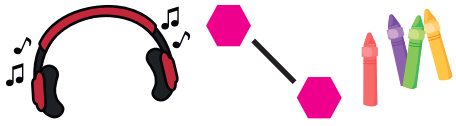

Listen, match and colour.

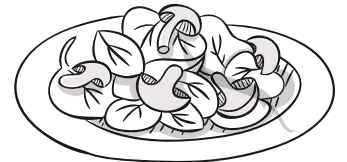
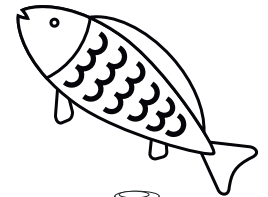
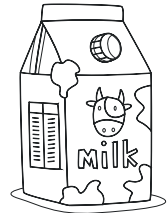
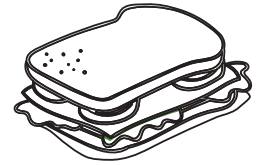

EnglishHouse

Lesson 08



Trace, listen and circle.

SCHOOL LUNCH MENU.

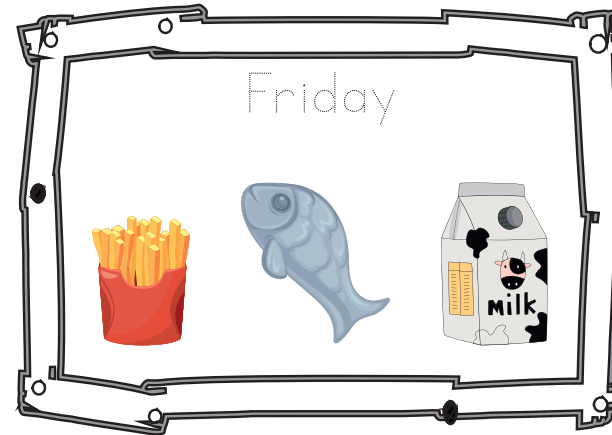
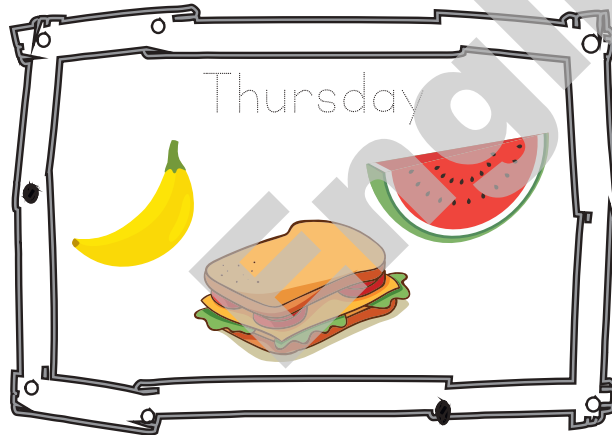
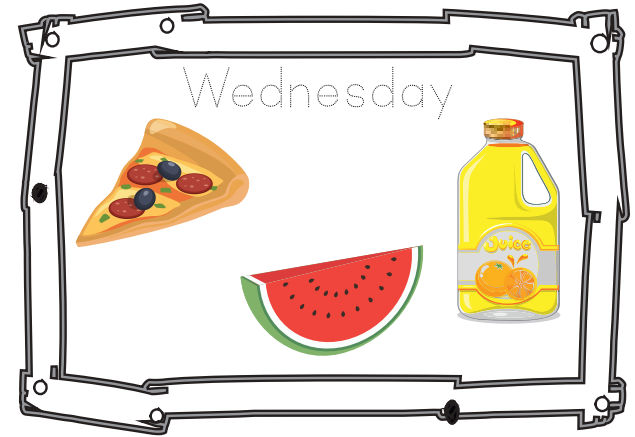
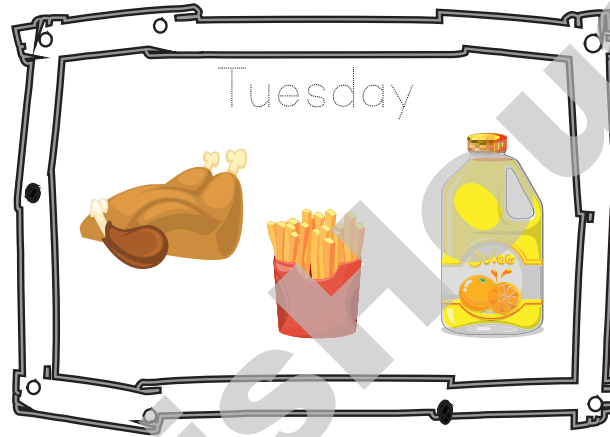
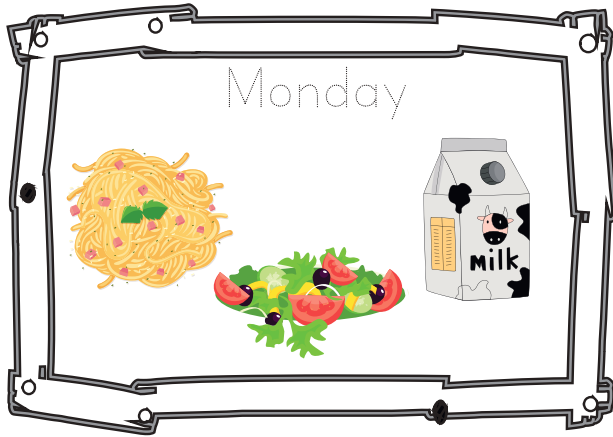

Lesson 09

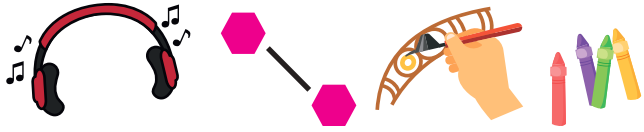

Listen, match, draw and colour.

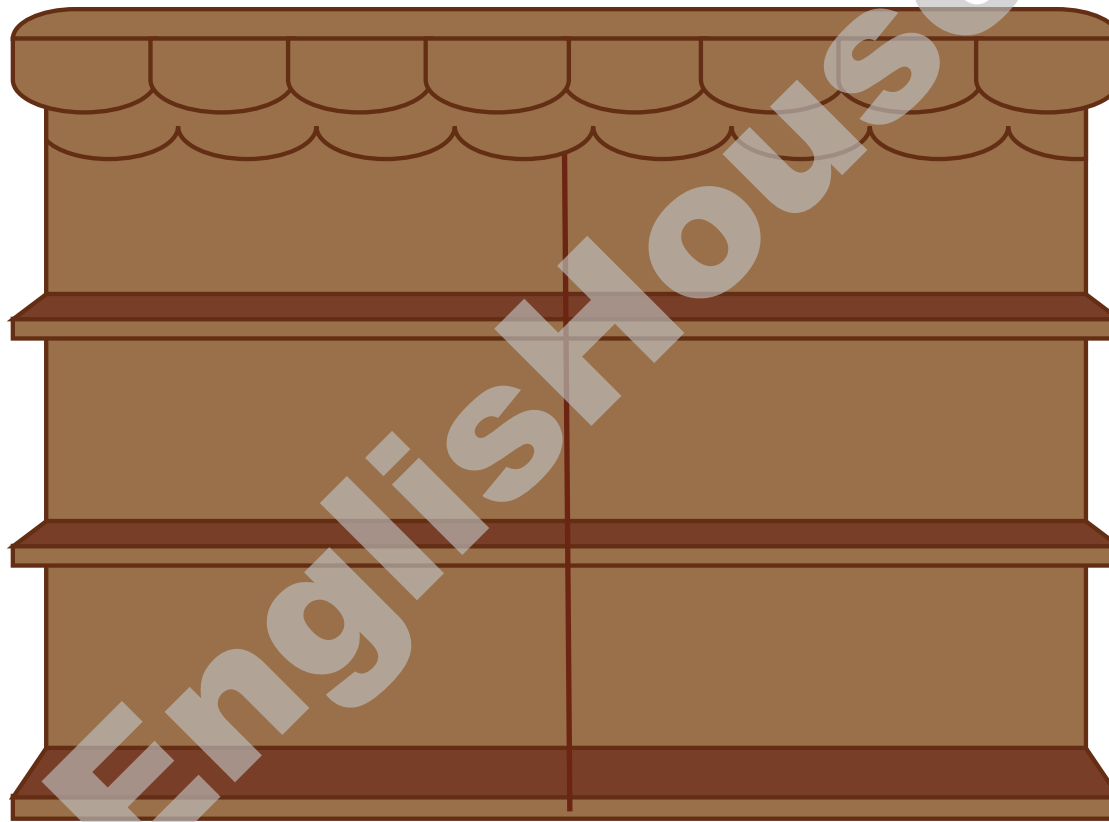

Lesson 10



Listen, trace, match and colour.



Happy restaurant

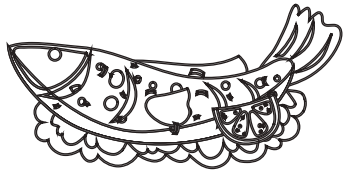
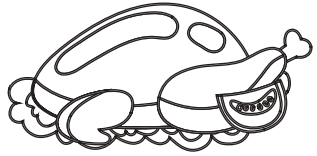

Monday

Tuesday

Wednesday

Thursday

Friday

Saturday

Sunday

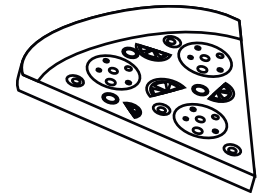
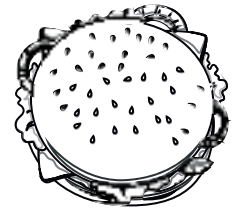
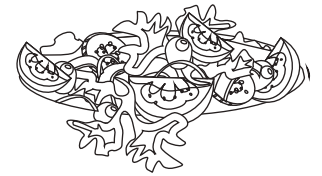
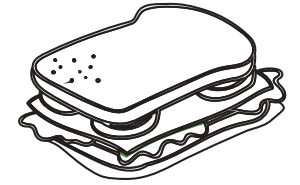

Lesson 11



Colour, cut, listen and paste.

Monday

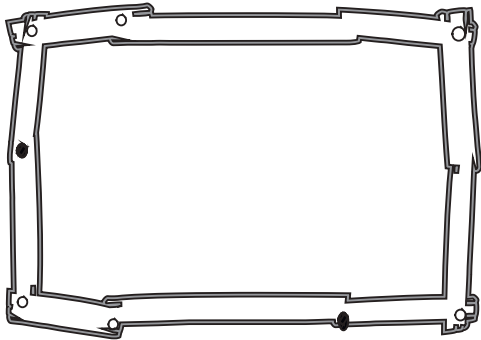

Tuesday

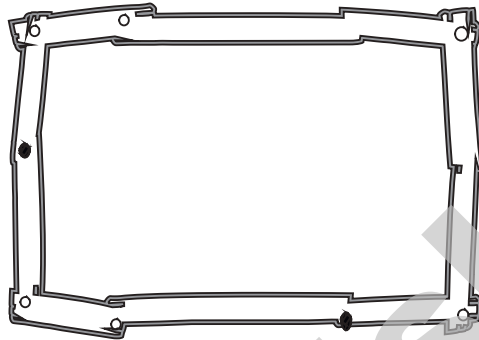

Wednesday

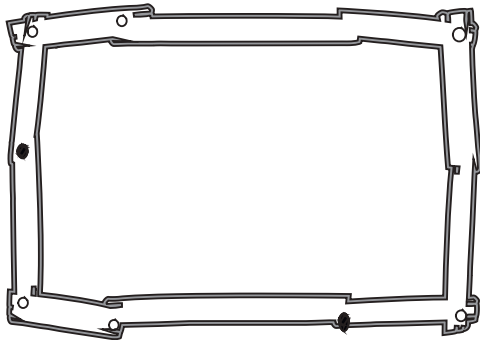

Thursday

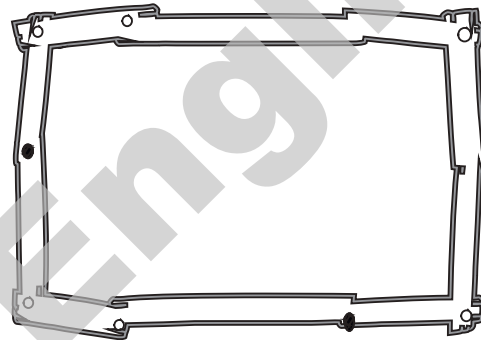

Friday

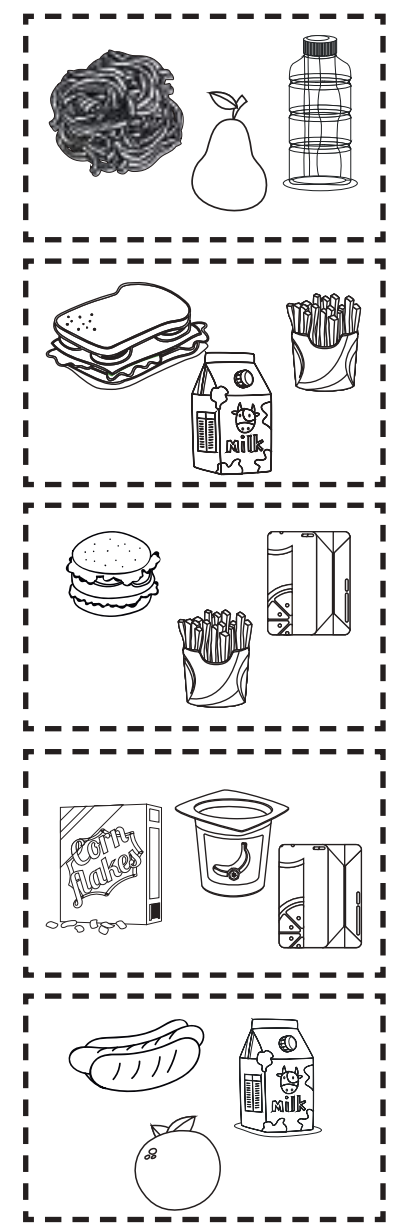
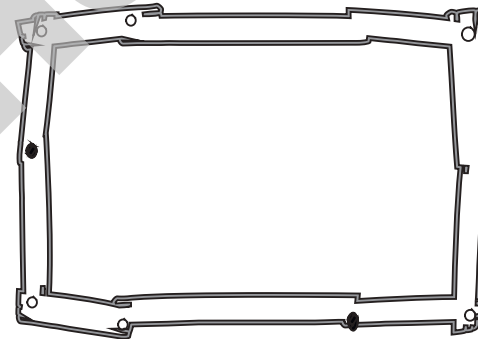

Lesson 12

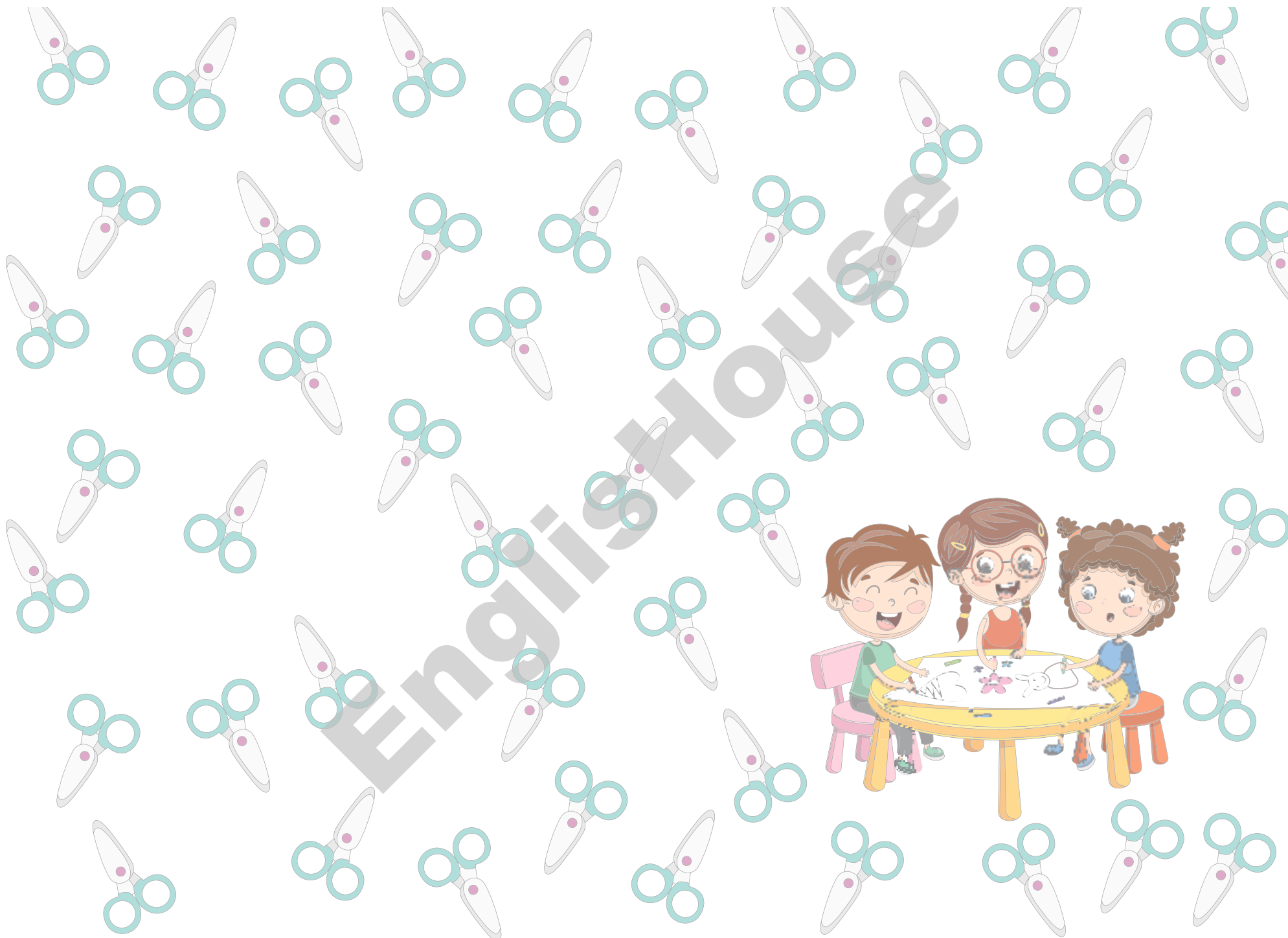



Listen, trace and colour.

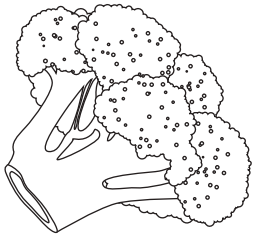

broccoli

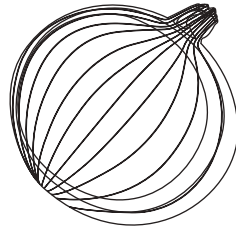

onion

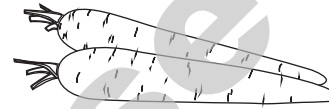

carrot



lettuce

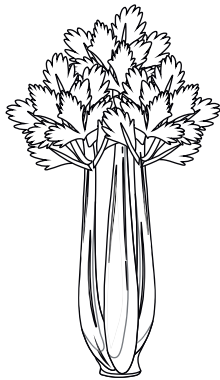

celery

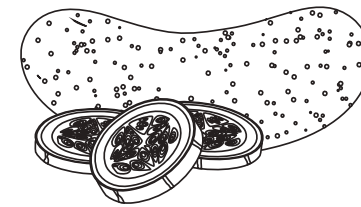

cucumber

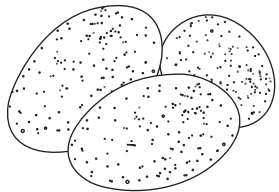

potato



Lesson 13



tomato



Trace, read and colour.

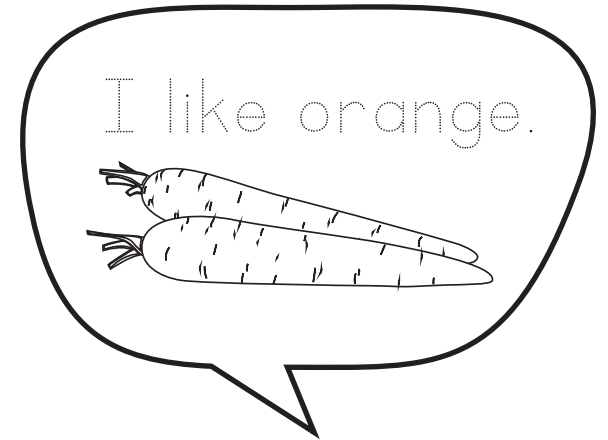
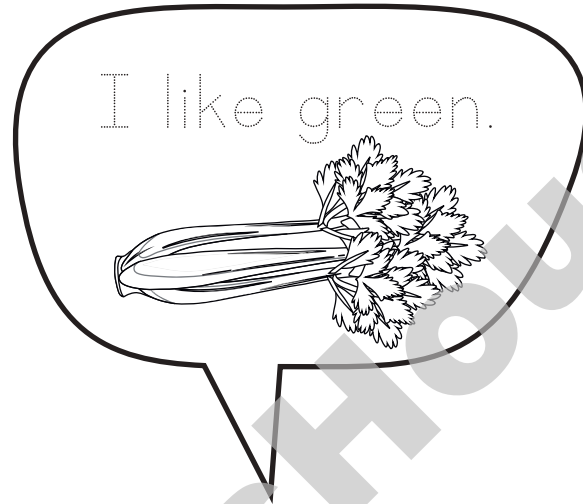
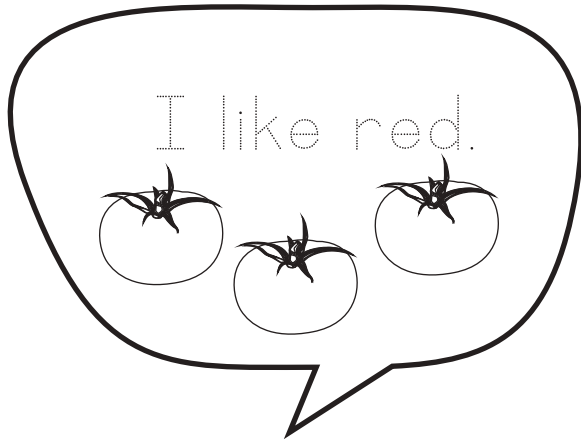

Lesson 14



Listen, draw and ask.

like



don't like

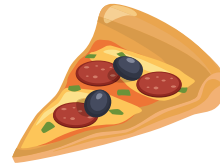
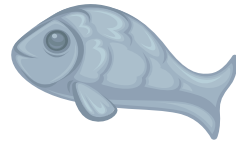

Friend

Me

Lesson 15

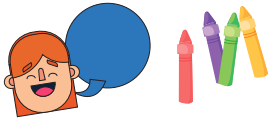

Name and colour.



Lesson 16



Colour, cut and paste.

Fruit	Vegetables

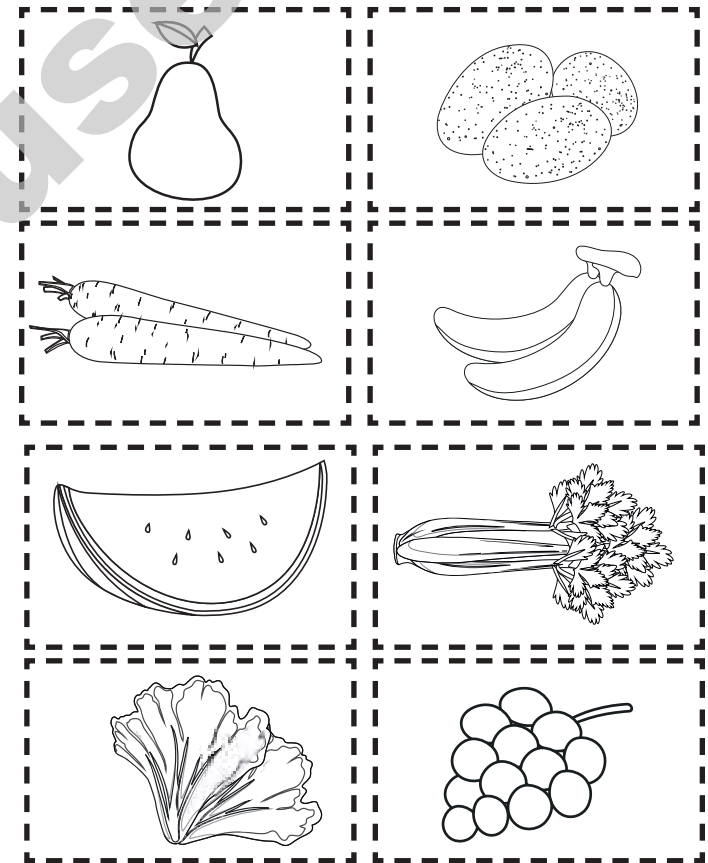



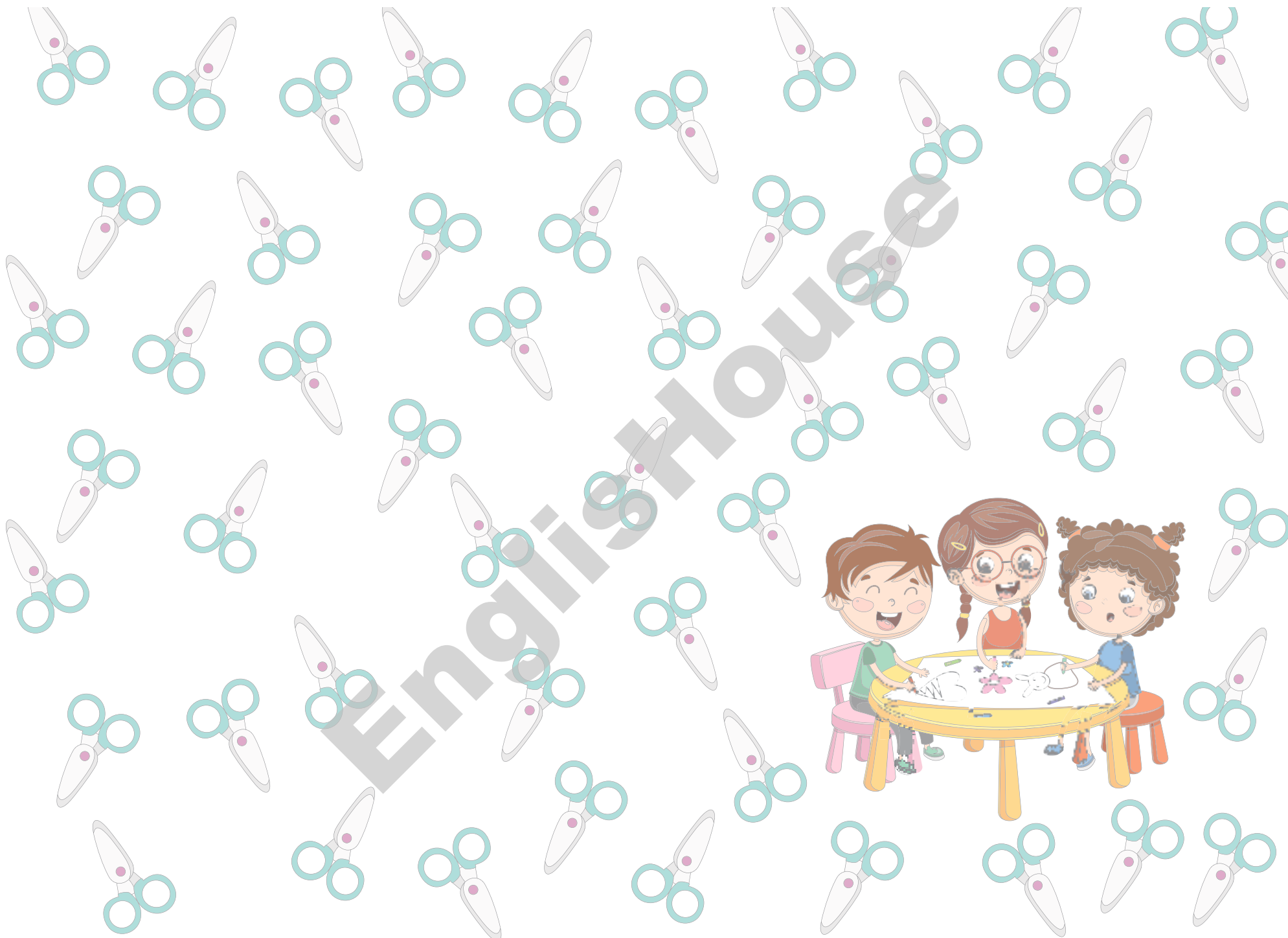





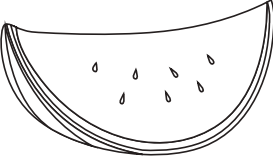



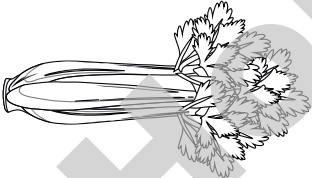

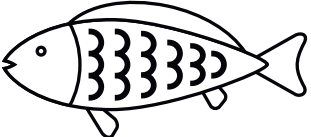
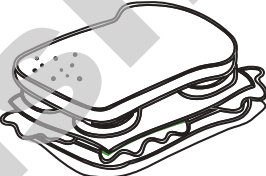
Lesson 17



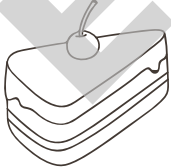
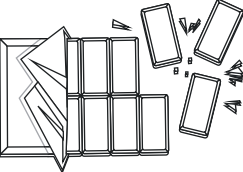

Draw and colour.

Fruit				
vegetables				
food				
drinks				
dessert				

Lesson 18

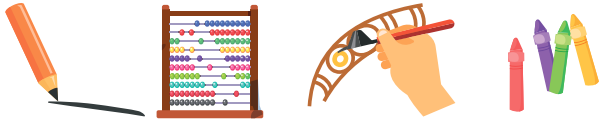

Trace, count, draw and colour.

13

thirteen.



14

fourteen.

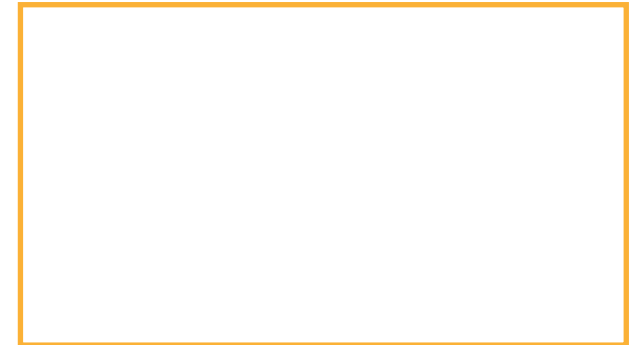
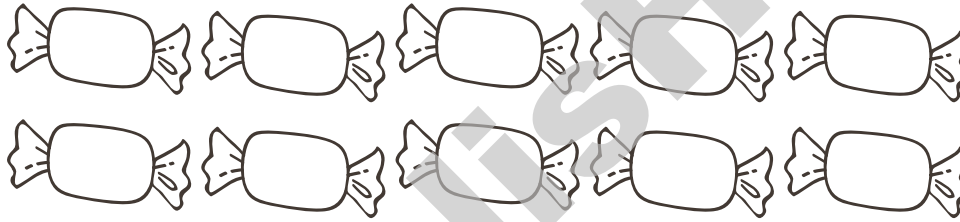

15

fifteen.

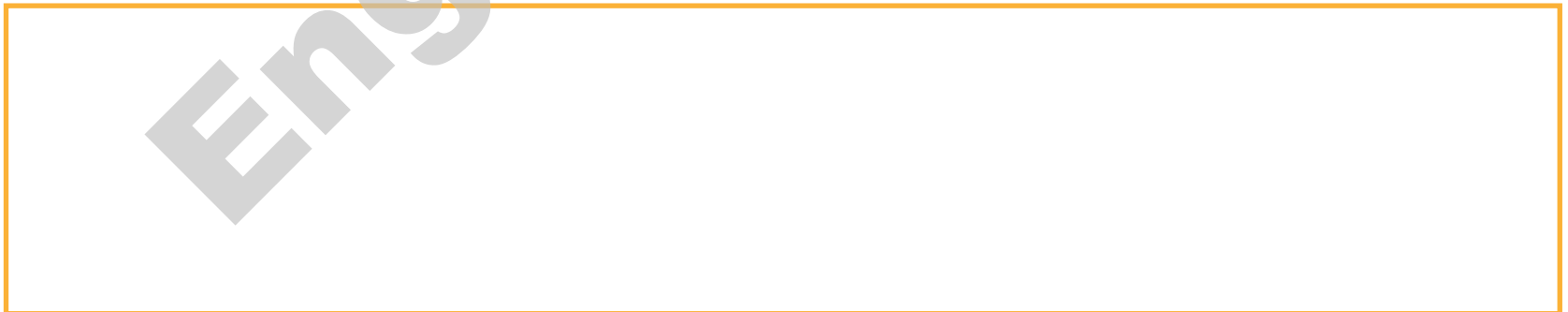

Lesson 19



Colour, cut and paste.

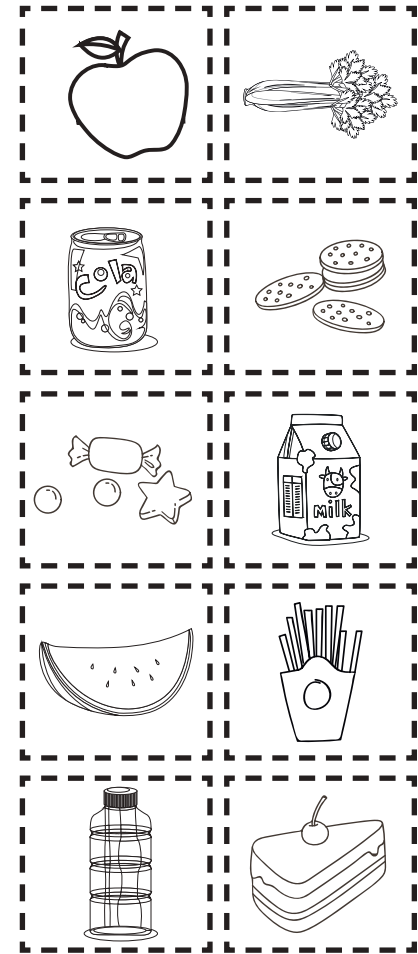
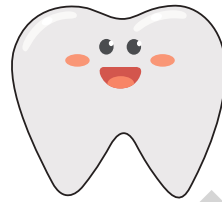

Lesson 20

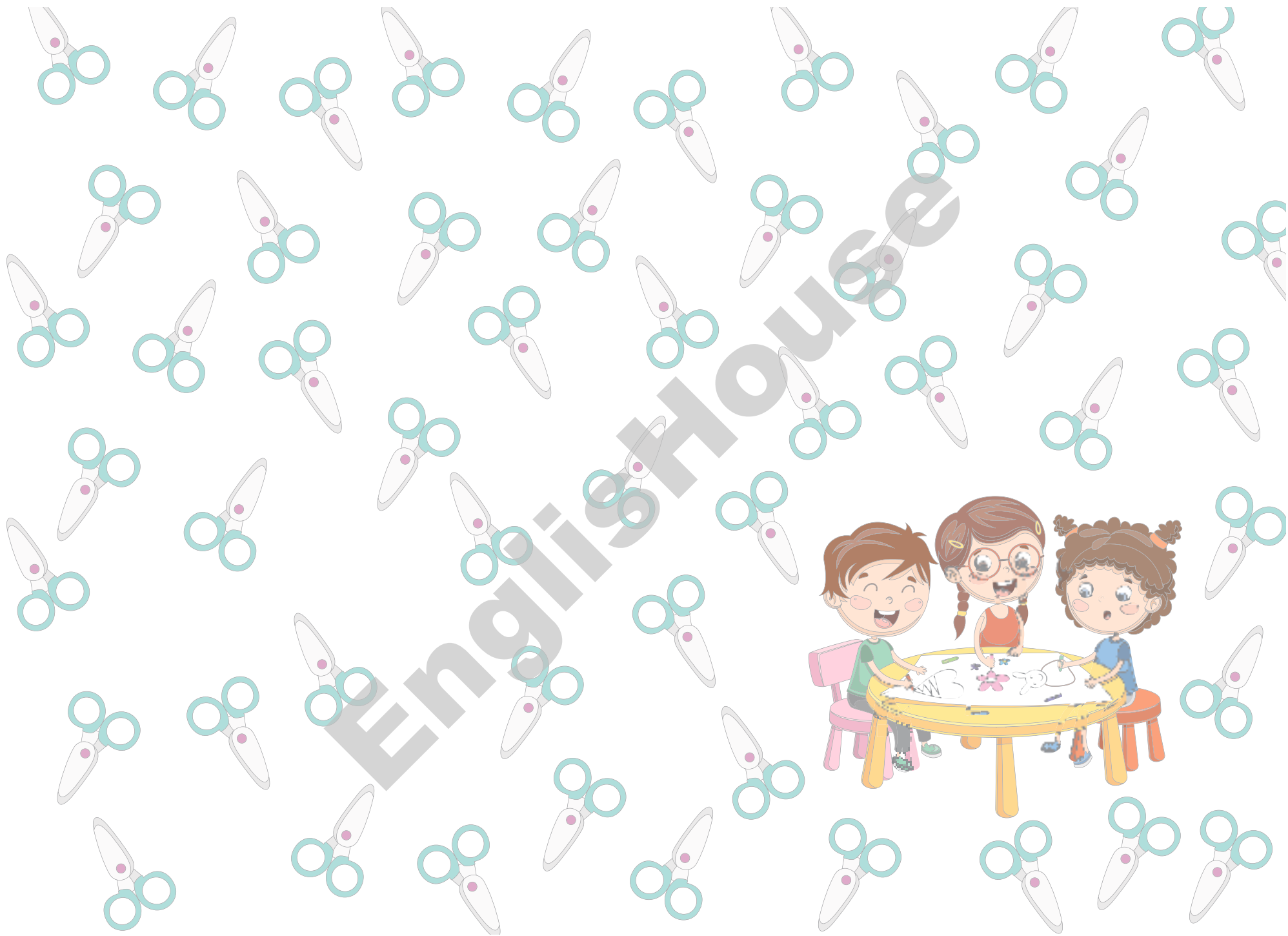



Trace and colour.

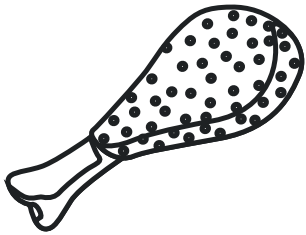

chicken

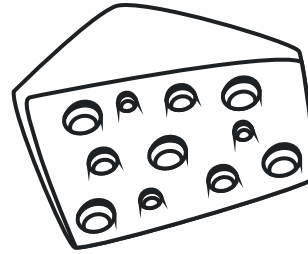

cheese



milk



cream



yogurt

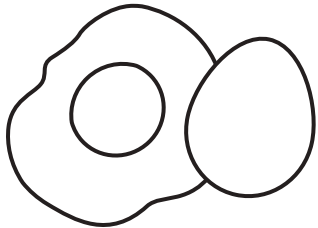

eggs

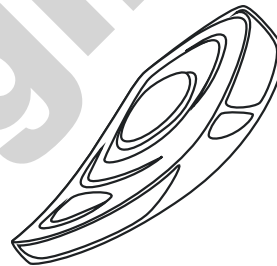

meat

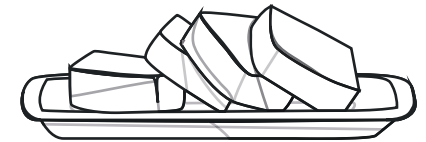

cbutter

Lesson 21



Trace and colour.

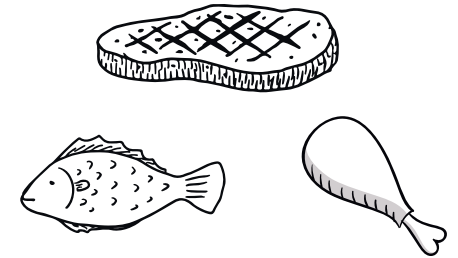
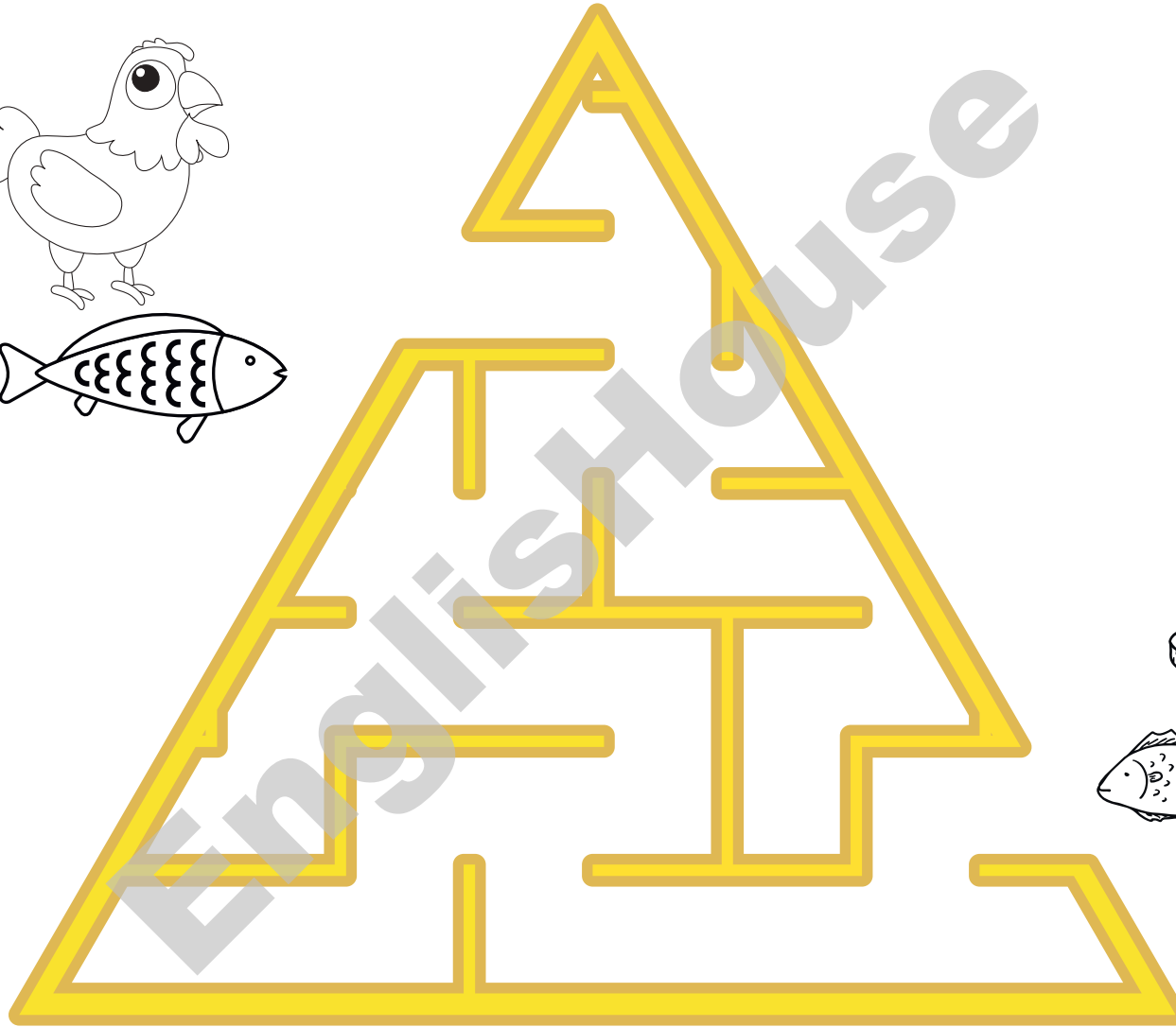
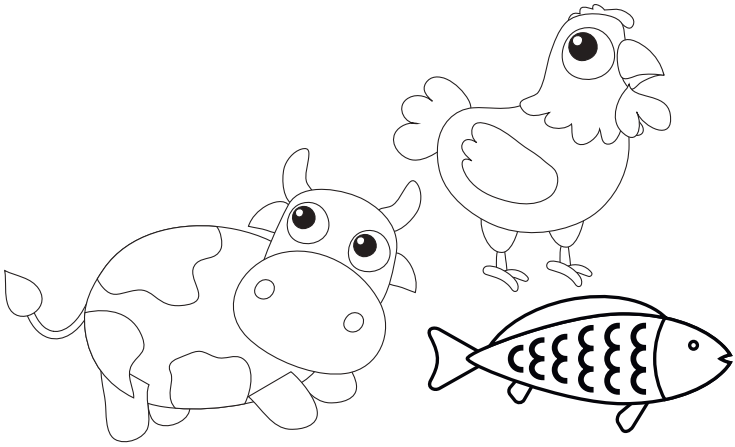

Lesson 22

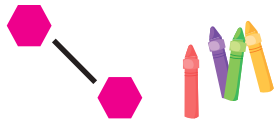

Match and colour.

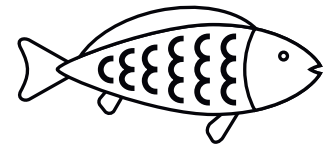
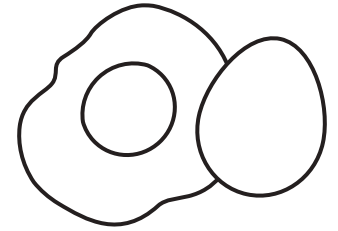
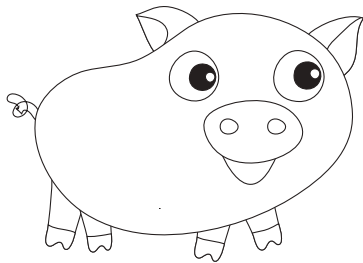
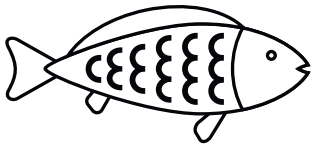
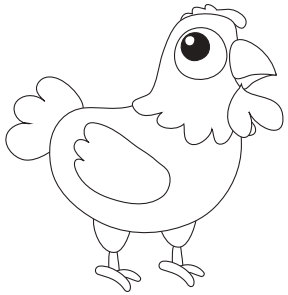
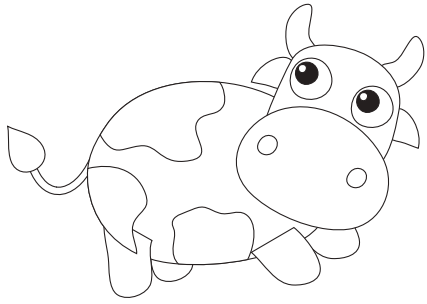

EnglishHouse

Lesson 23



Trace and colour.

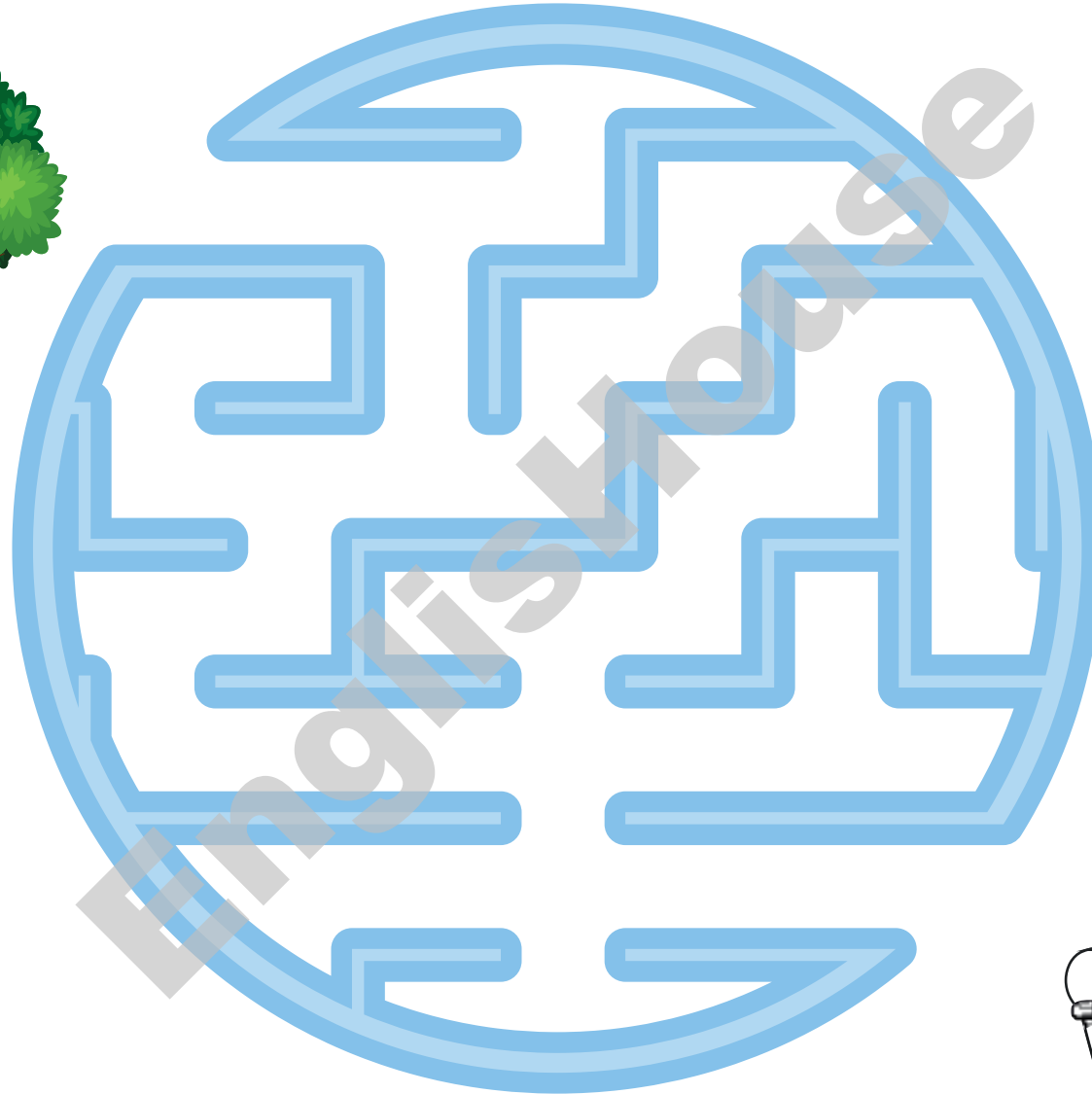

Lesson 24

Show What You
Know!



EnglishHouse



Listen and colour.

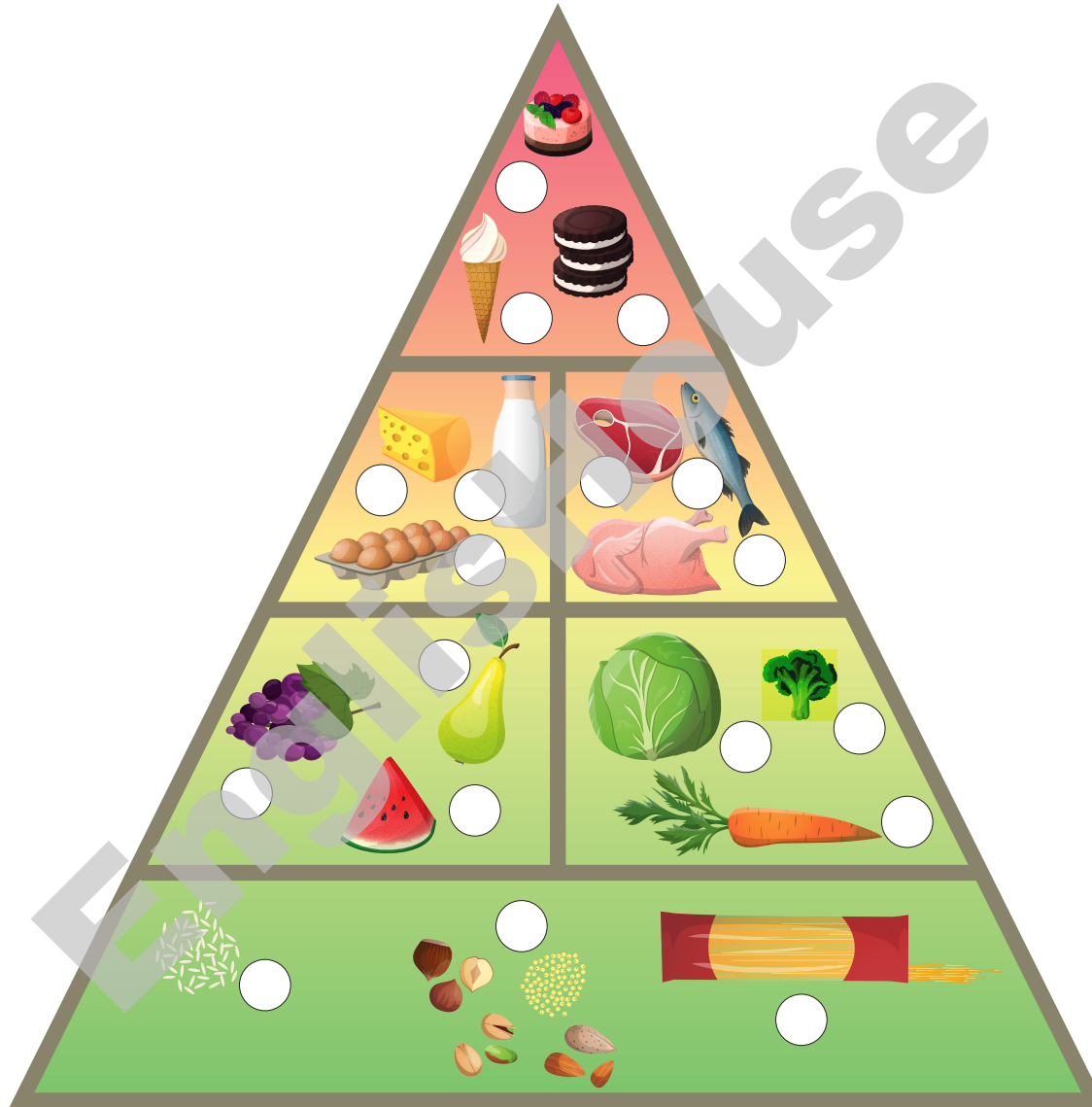

Lesson 25



Listen, draw and colour.

I like



I don't like

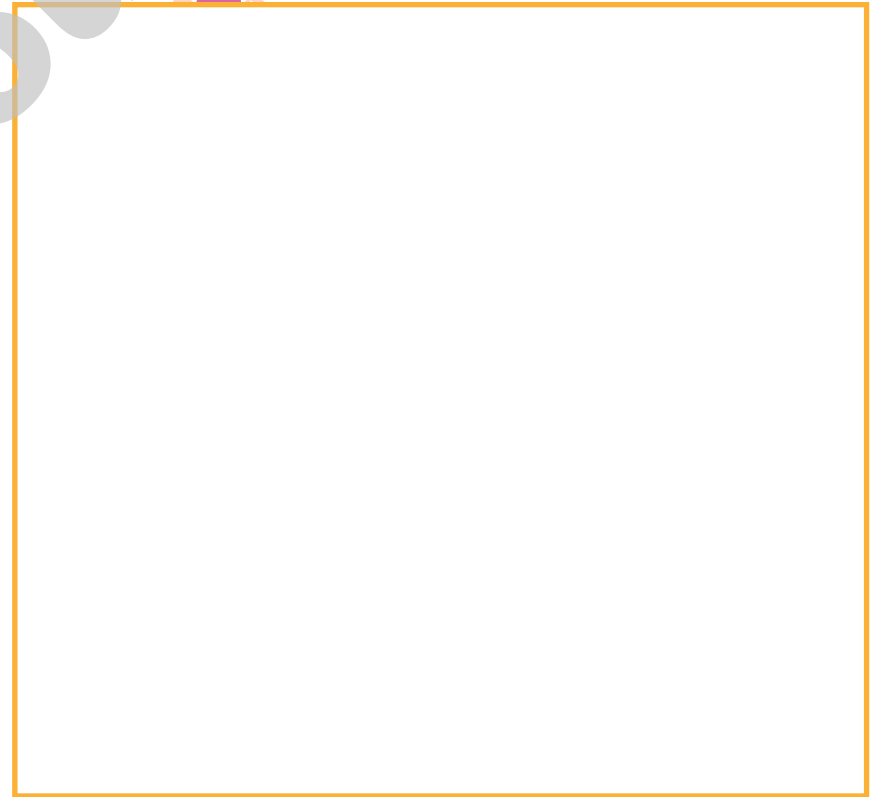

EnglishHour.com

Lesson 26



Trace, draw and colour.

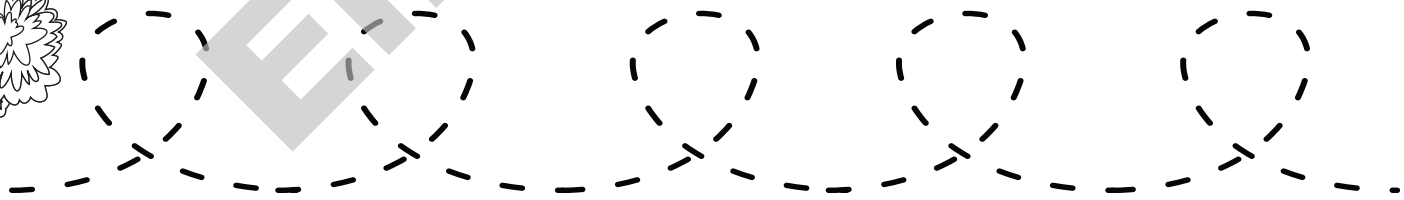
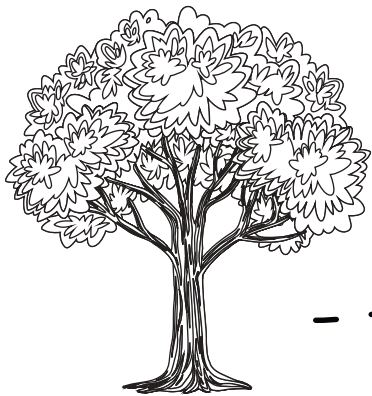
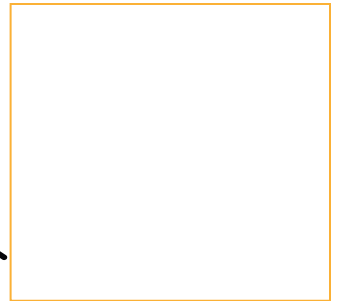
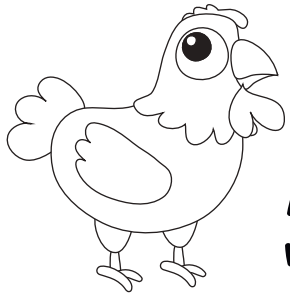
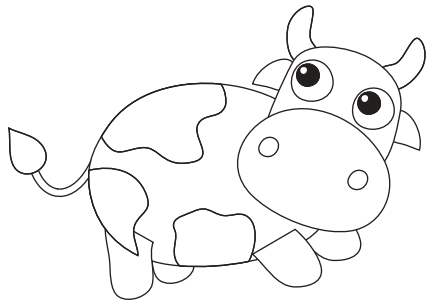

Lesson 27

Unit 5

Discovering Places

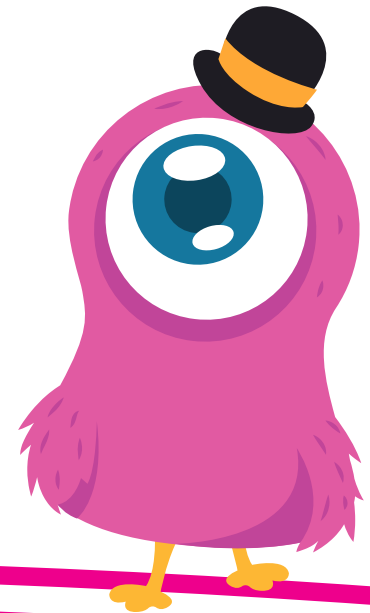



EnglishHouse

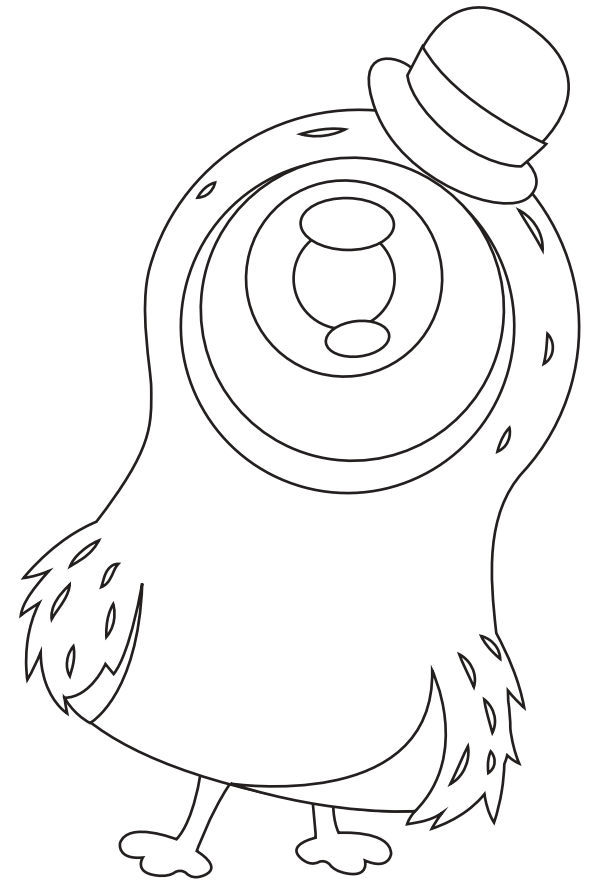



Trace and colour.

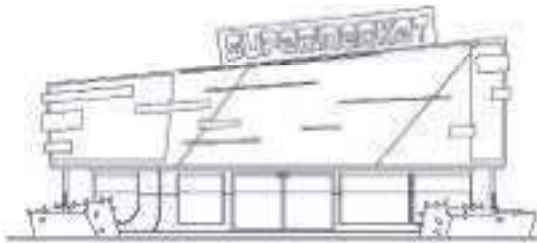

supermarket



park

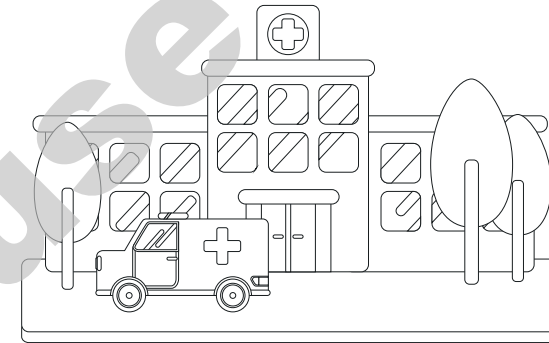

hospital

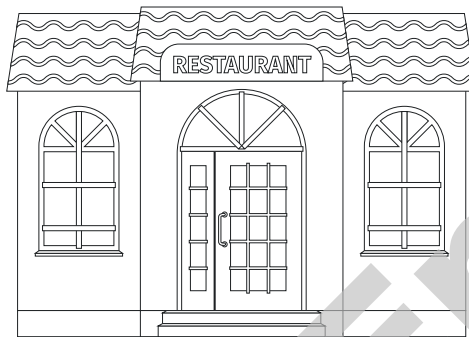

restaurant

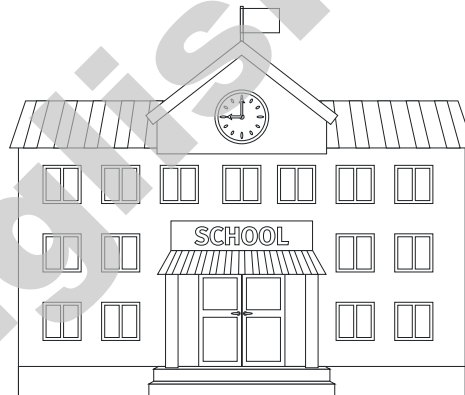

school



bank

Lesson 01



Listen, match and colour.

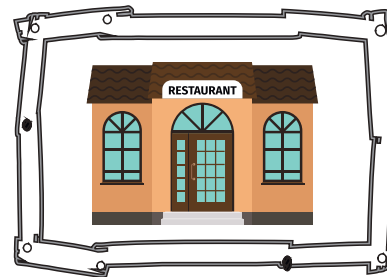
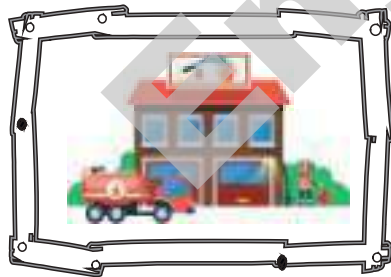

Lesson 02



Colour, cut, listen and paste.



Lesson 03

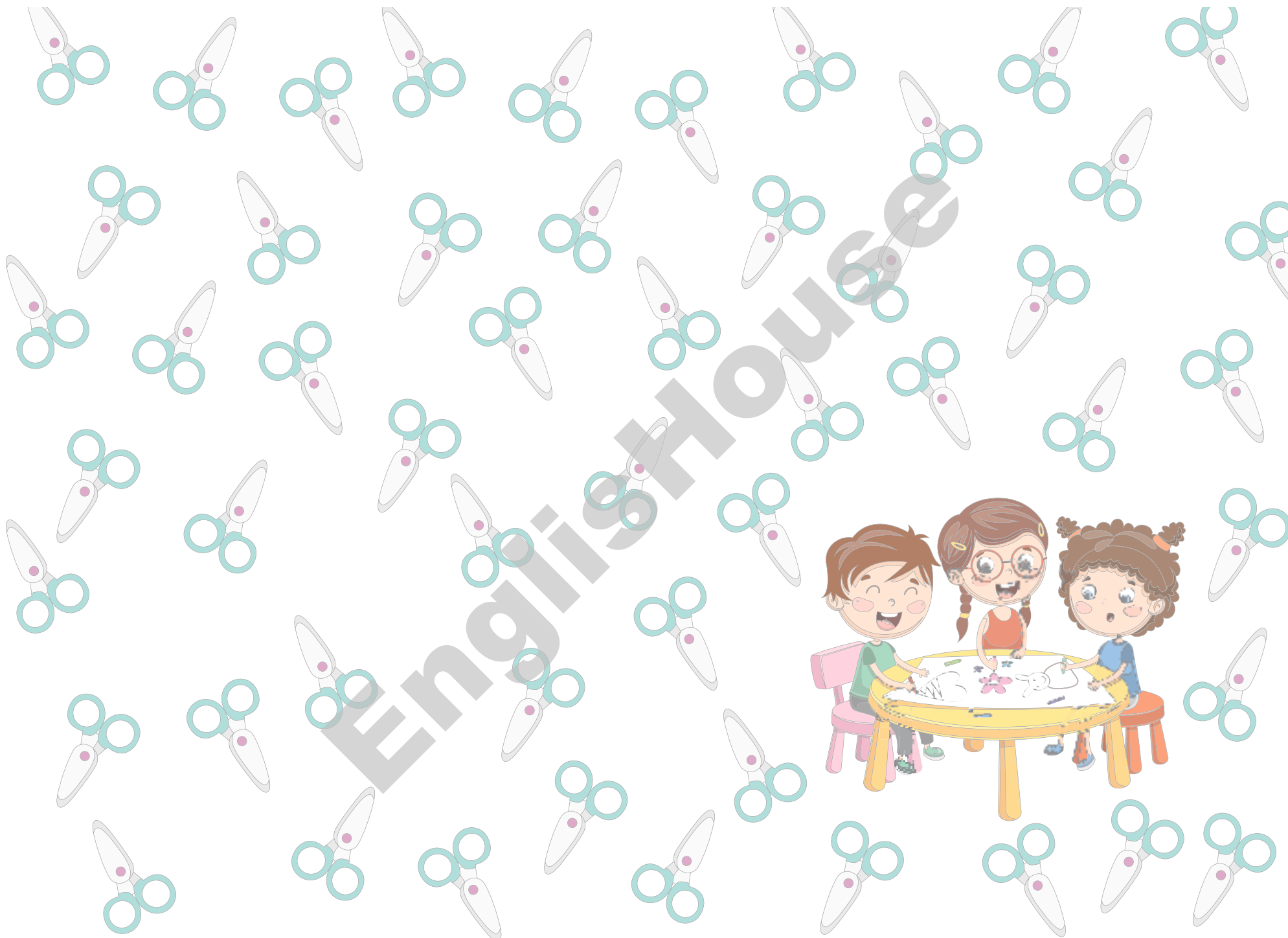

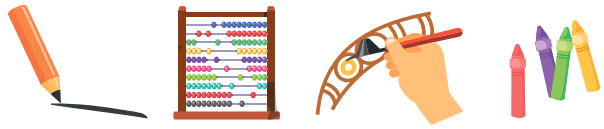

Trace, count, draw and colour.

16

sixteen.

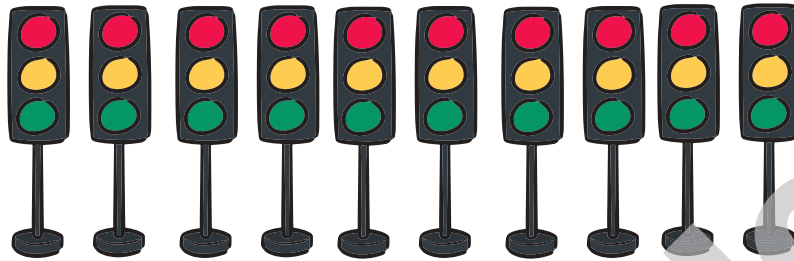

17

seventeen.

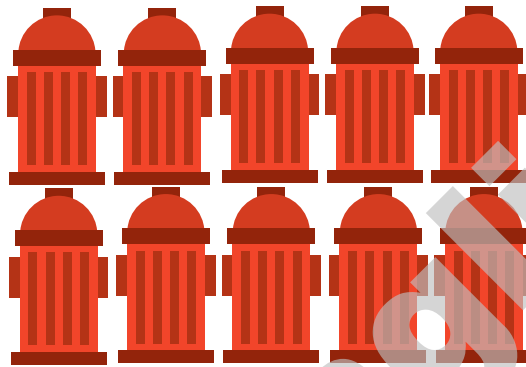

18

eighteen.



Lesson 04

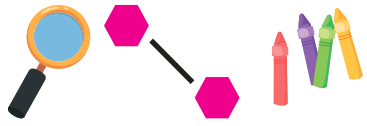

Look, match and colour.

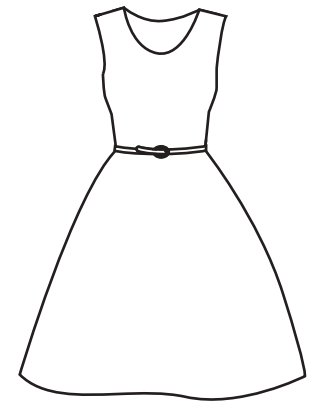
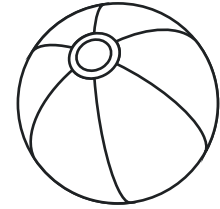

EnglishHouse

Lesson 05



Look, draw and colour.



Lesson 06

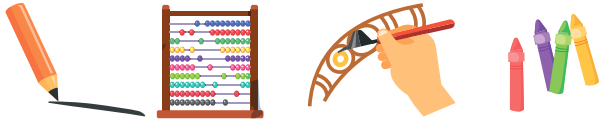

Trace, count, draw and colour.

19

nineteen.

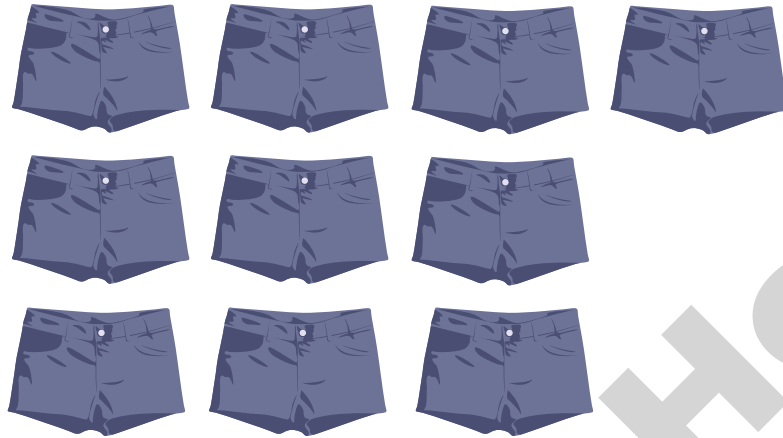

20

twenty.

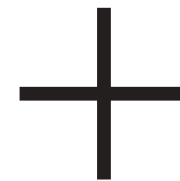
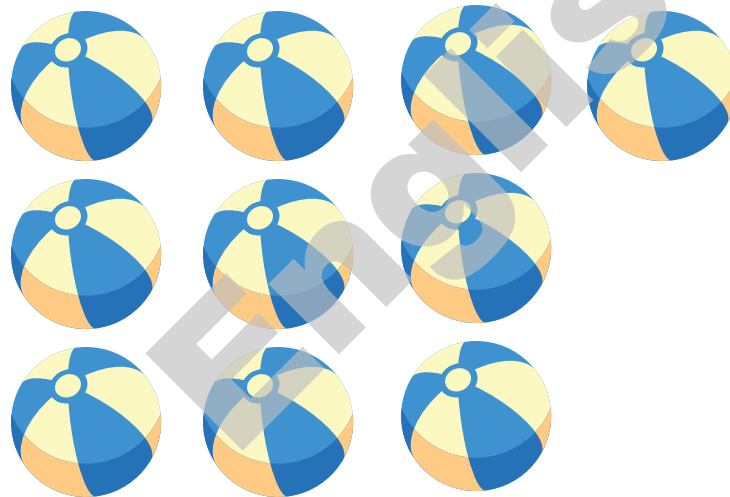

Lesson 07



Trace, cut and paste.

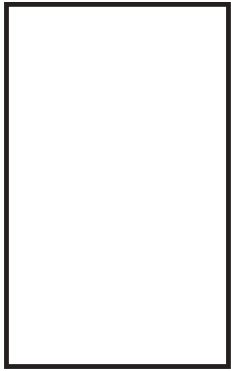

police officer

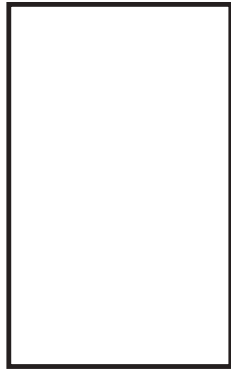

teacher



doctor

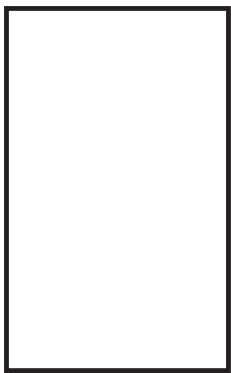

waiter



nurse



firefighter

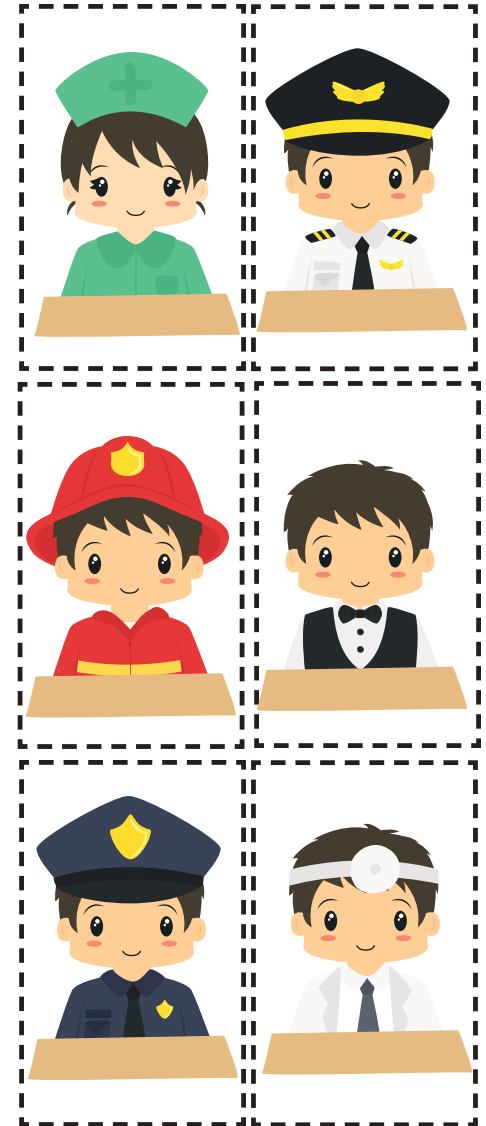

Lesson 08

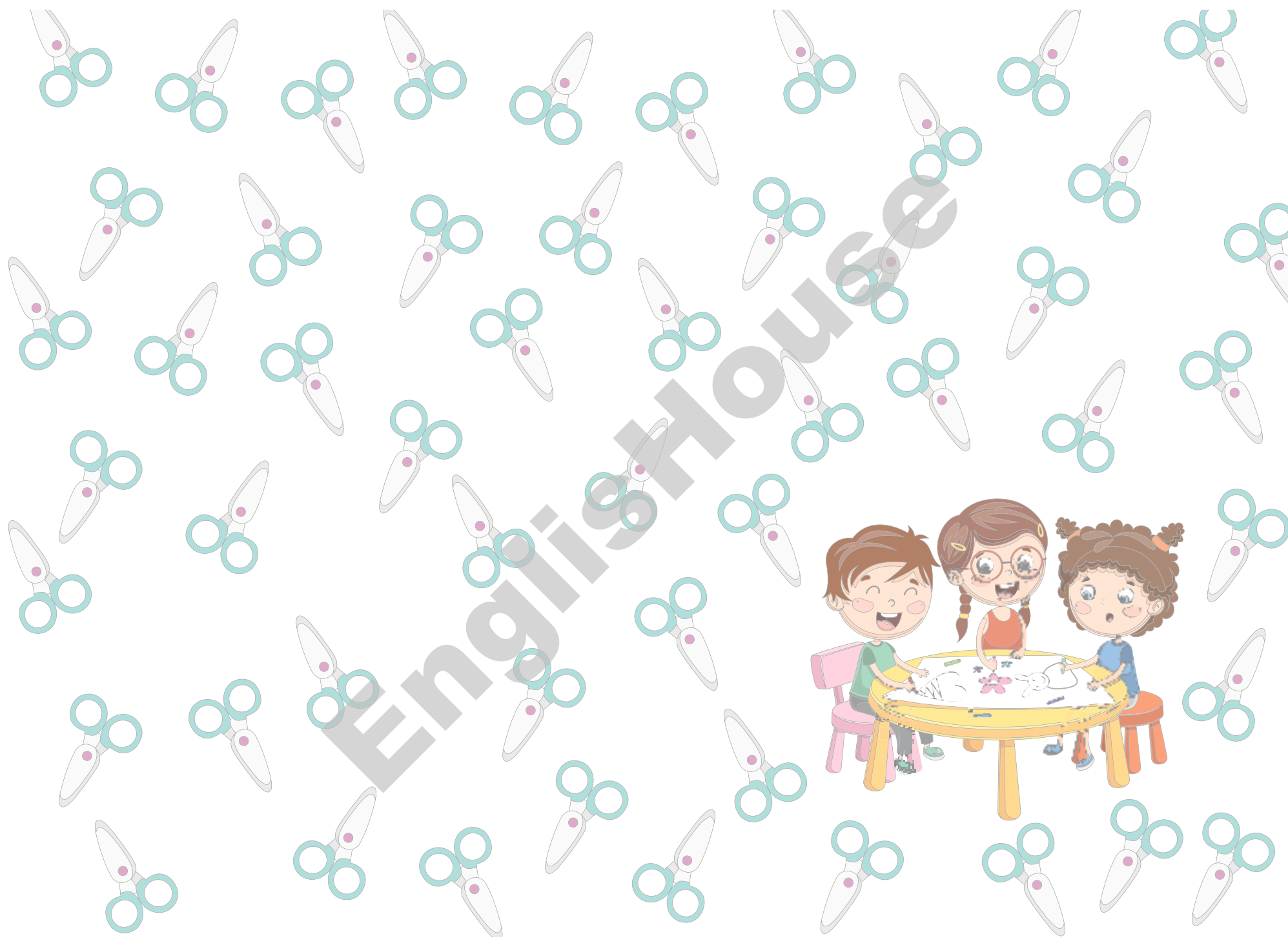

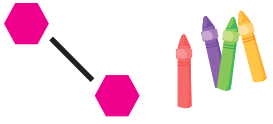

Match and colour.

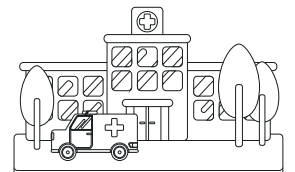
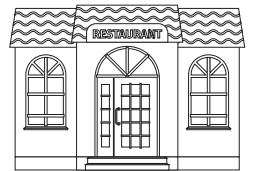
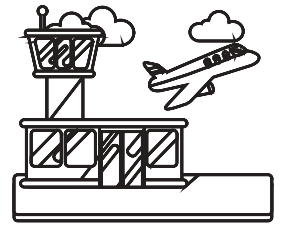
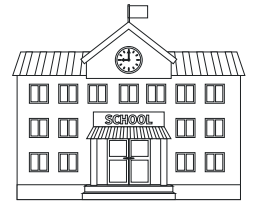

EnglishHouse

Lesson 09

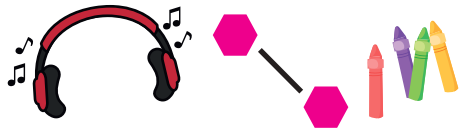

Listen, match and colour.

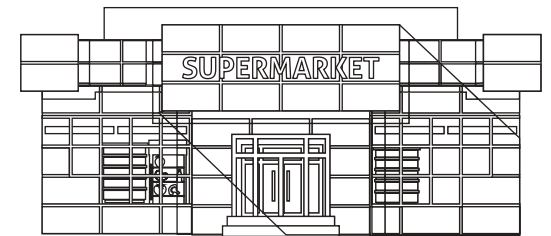
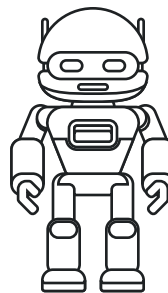
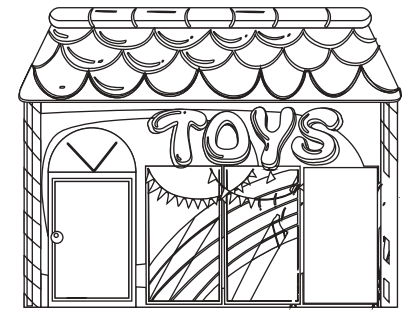
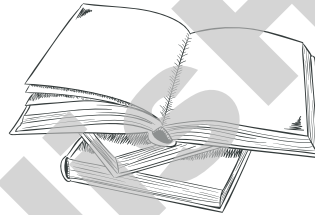
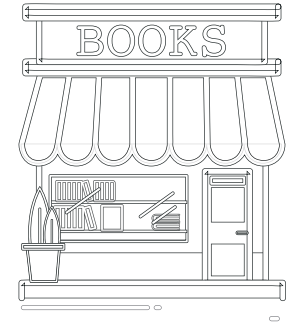
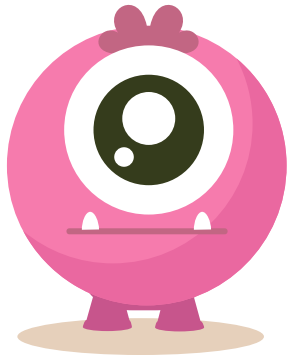

Lesson 10

Look, match and colour.

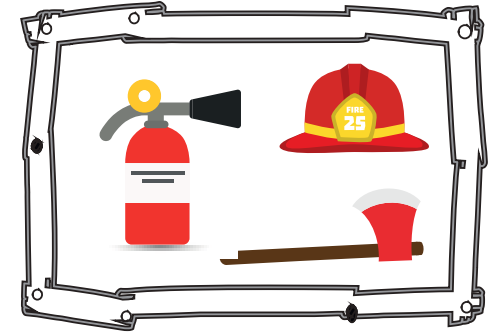
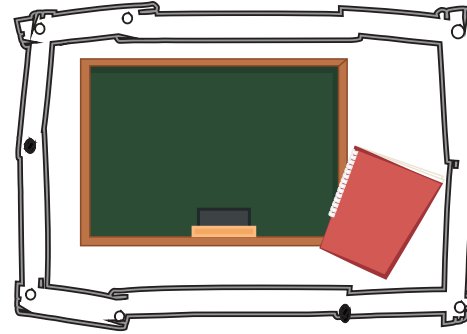
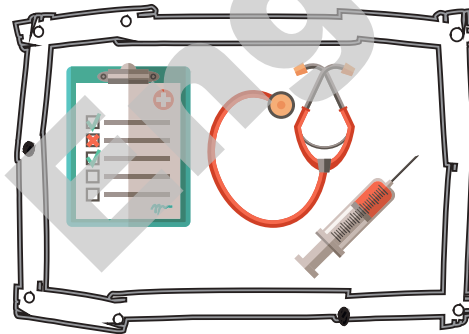
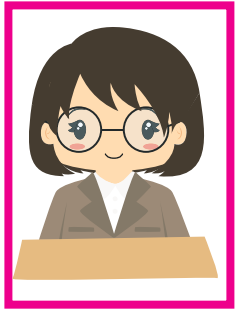
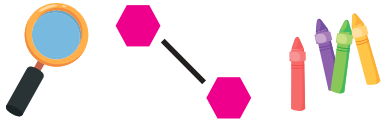

Lesson 11

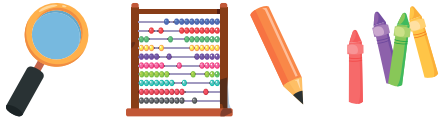

Look, count, write and colour.

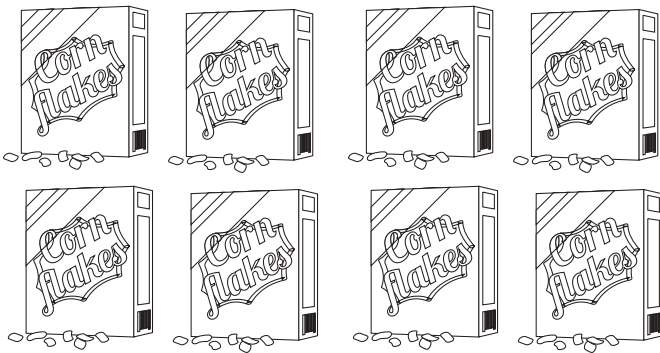
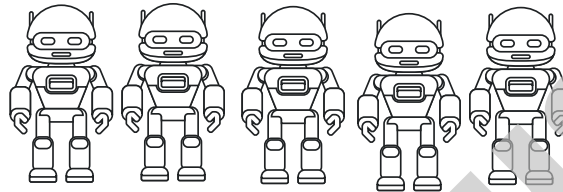
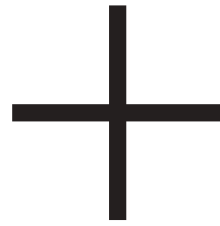
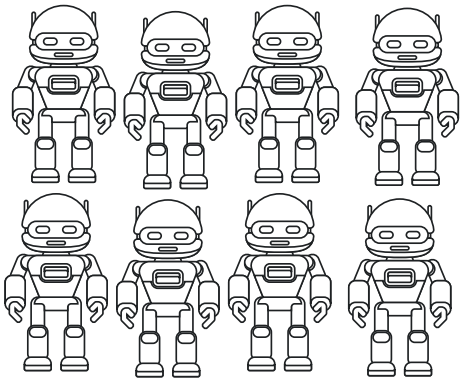

Lesson 12



Draw and colour.

I want to be a...



Lesson 13



Look, cross out and colour.

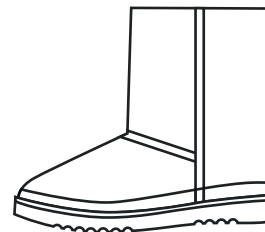
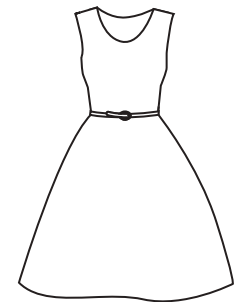
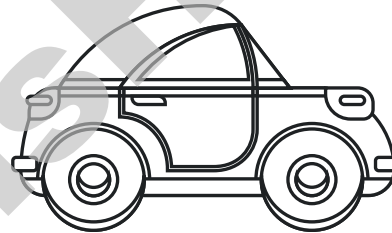
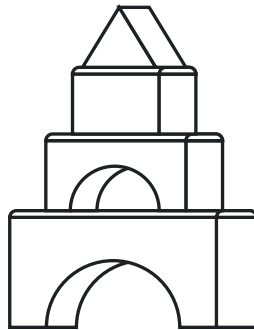
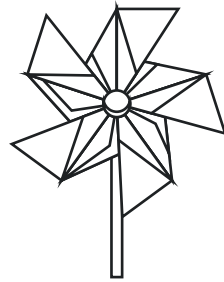

Lesson 14



Listen and circle.

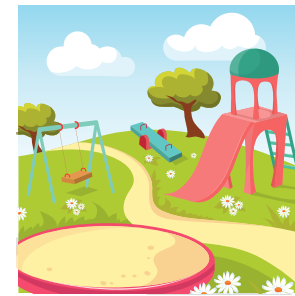
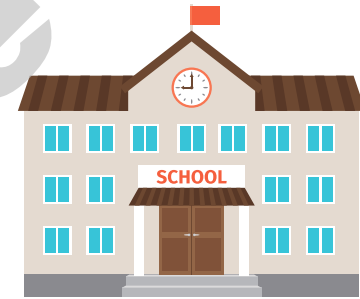
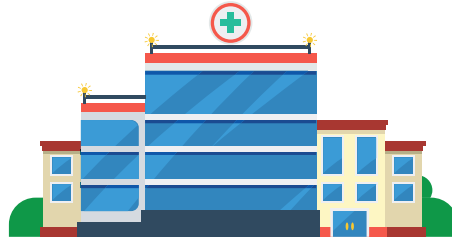

Lesson 15



Listen, colour and trace.

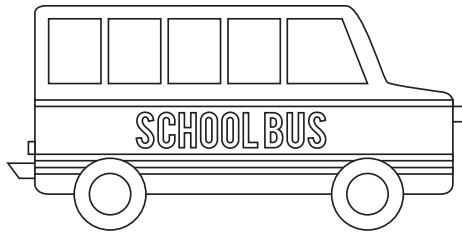

school bus

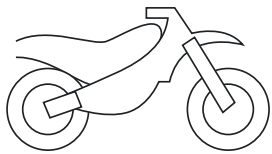

motorbike



car

In the city

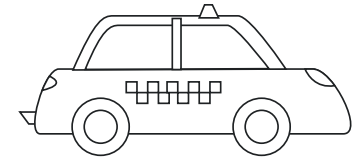

taxi

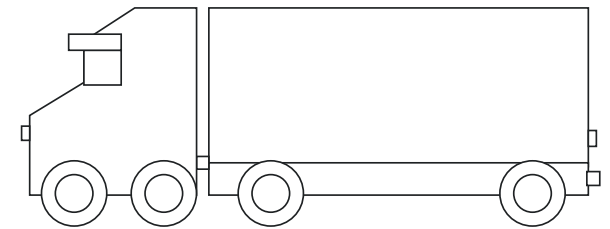

truck

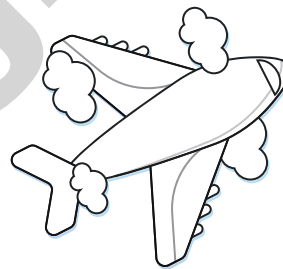

plane



train

Lesson 16

Listen, match and colour.

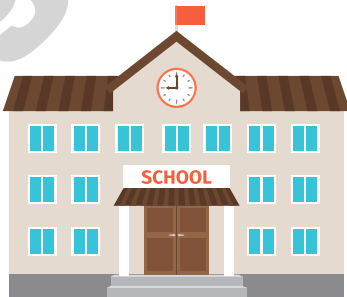
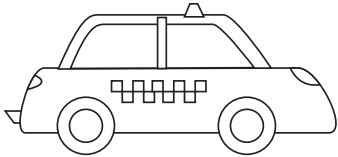

Lesson 17



Listen, point and play.



Lesson 18



Colour, cut and paste.

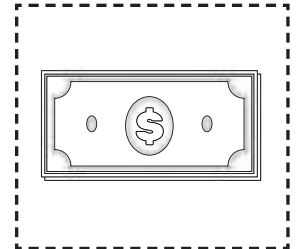
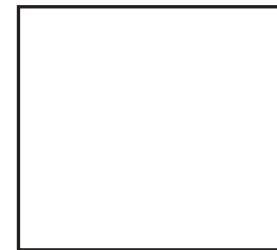
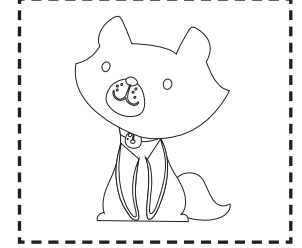
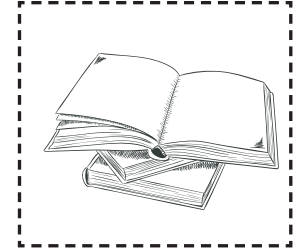

Lesson 19



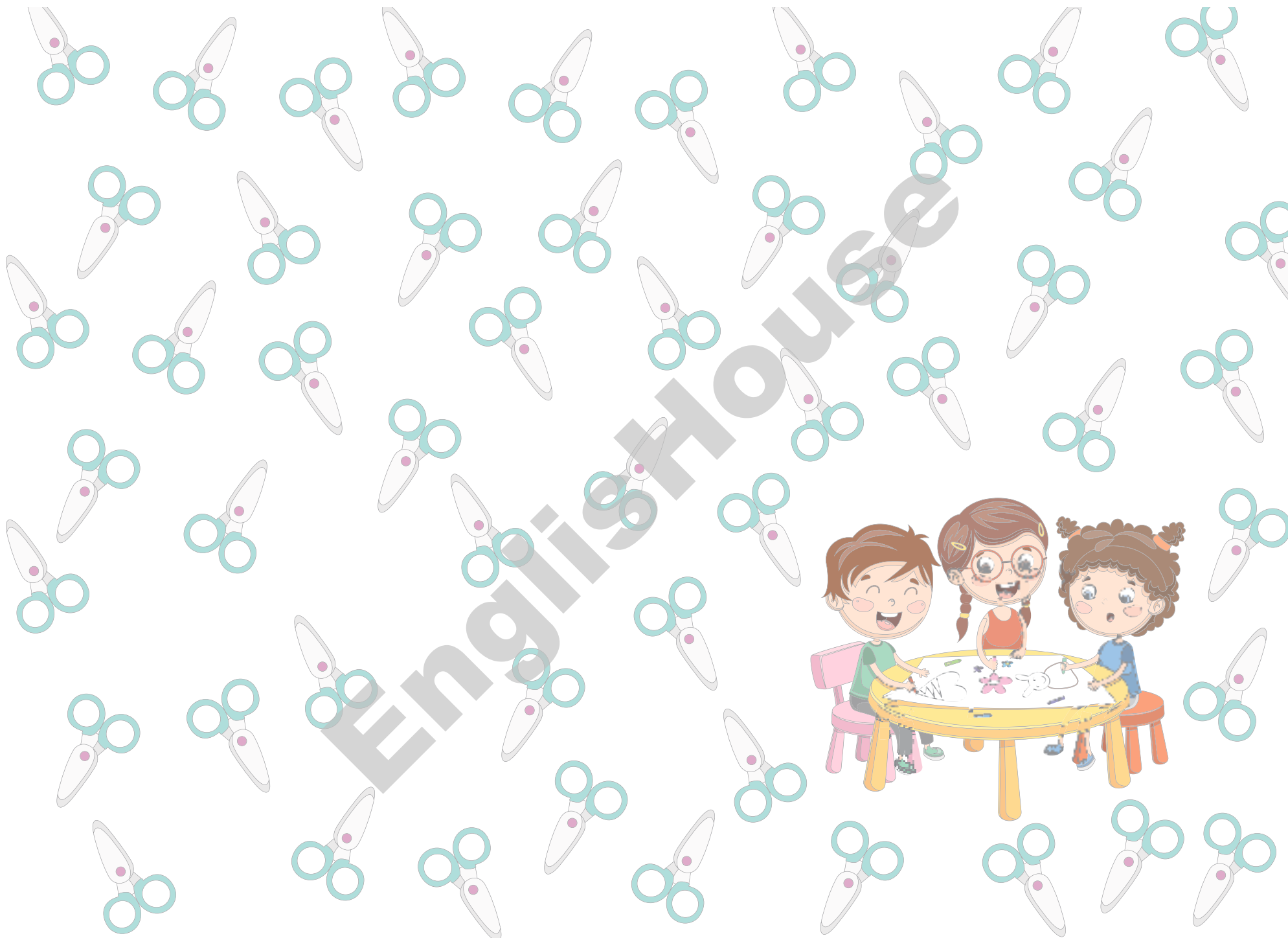



Trace and colour.



camping

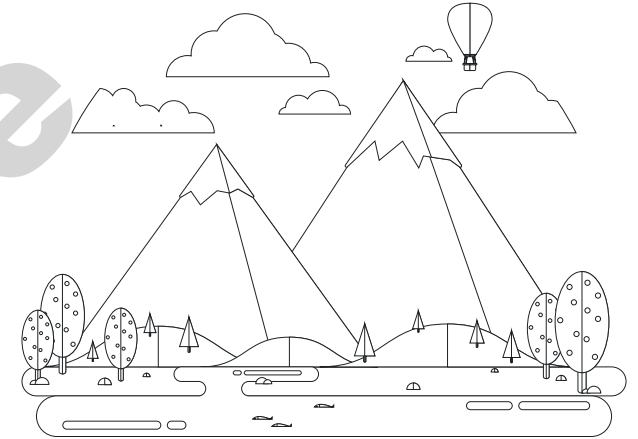

mountain

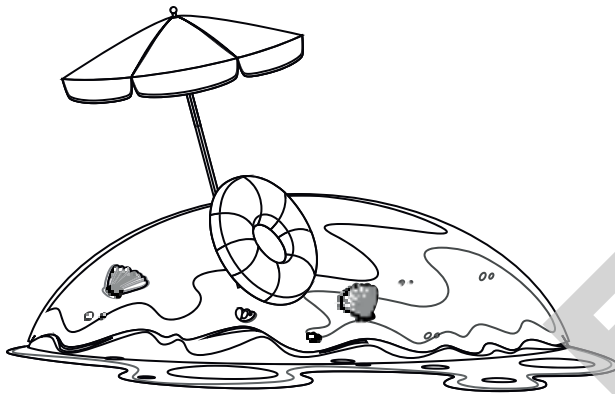

beach



Lesson 20



Listen, circle and colour.

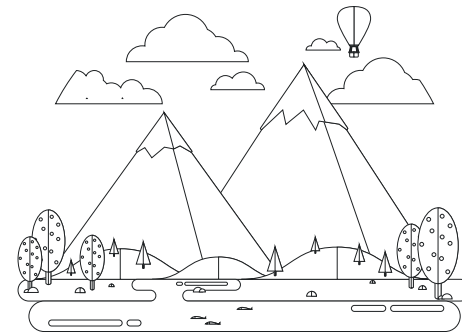
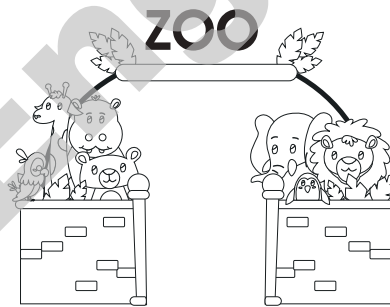
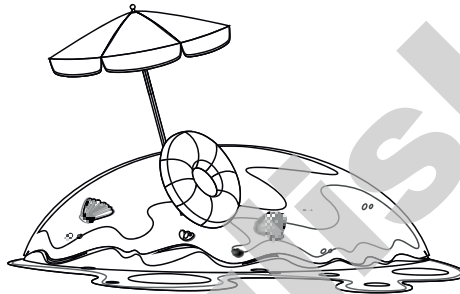
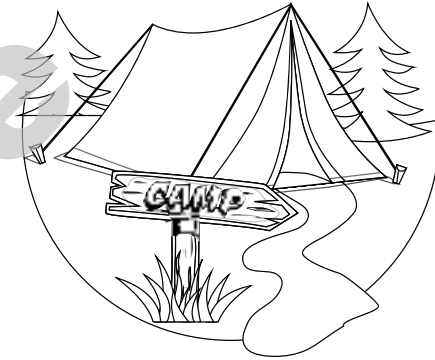
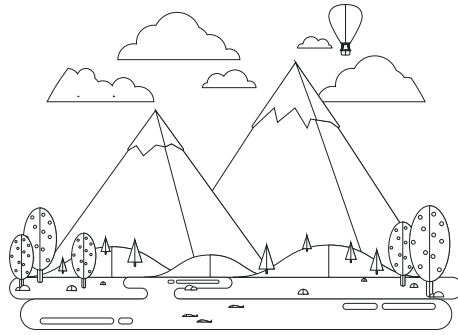

Lesson 21



Colour, cut and play.

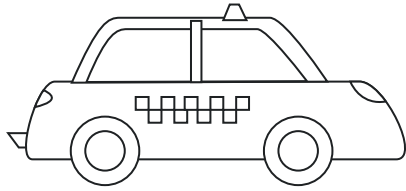

taxi

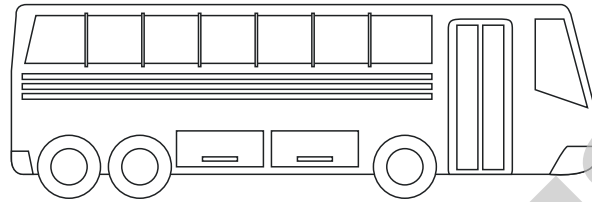

bus

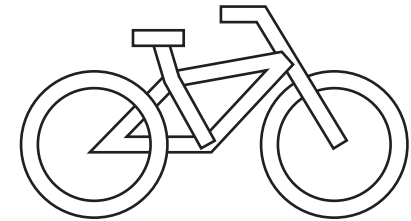

bike

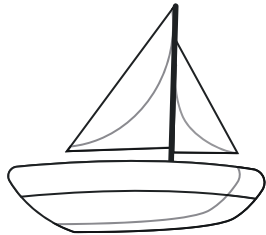

ship



train

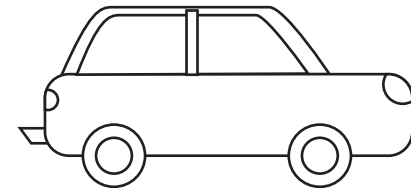

car

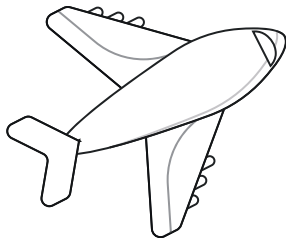

plane

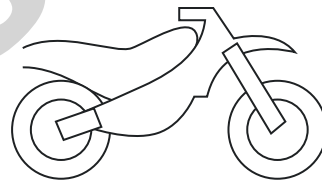

motorbike

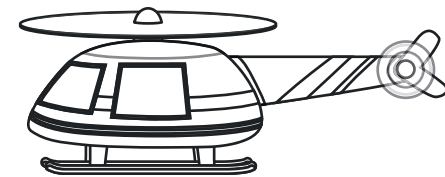

helicopter

Lesson 22

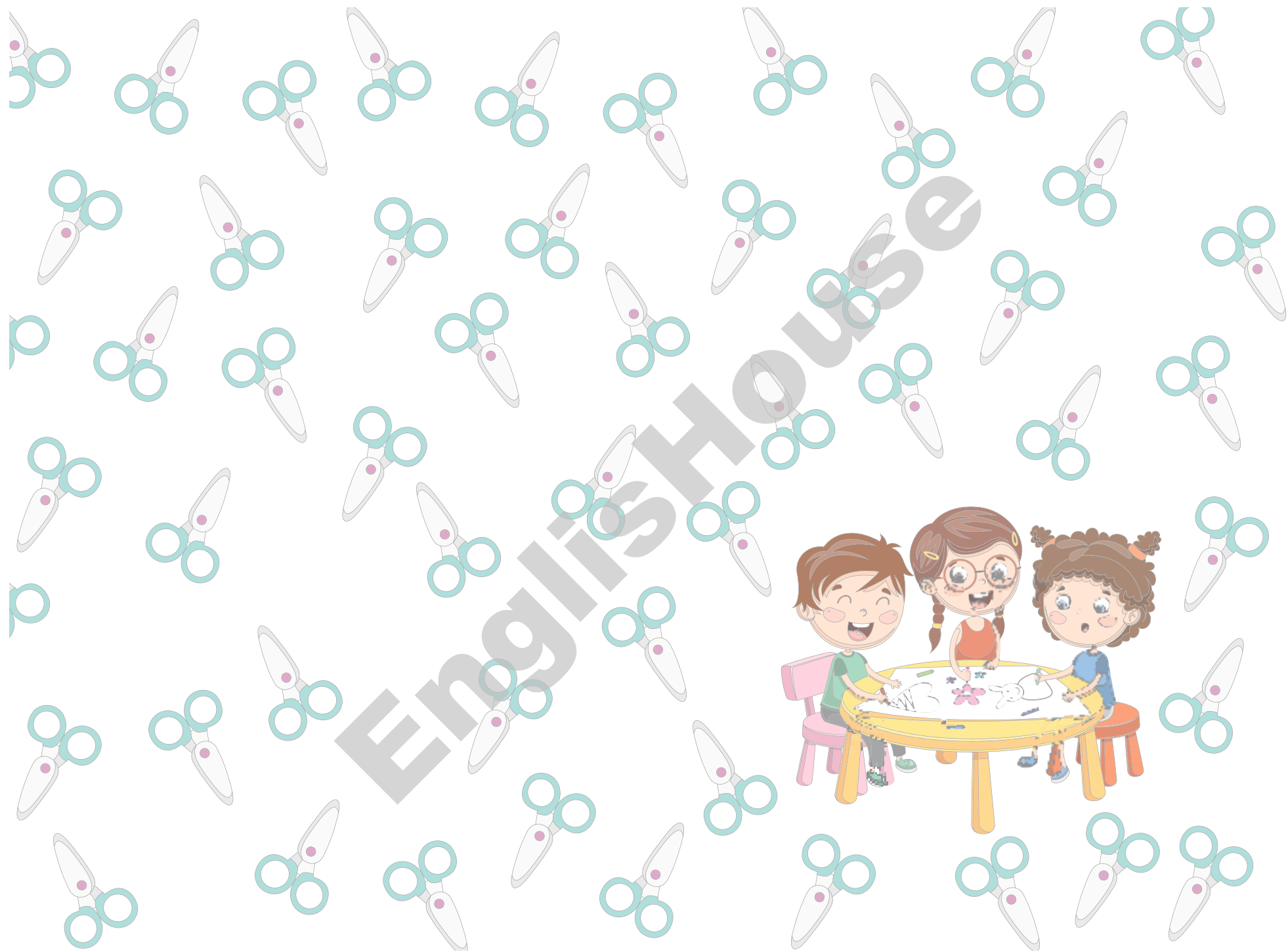



Trace and colour.

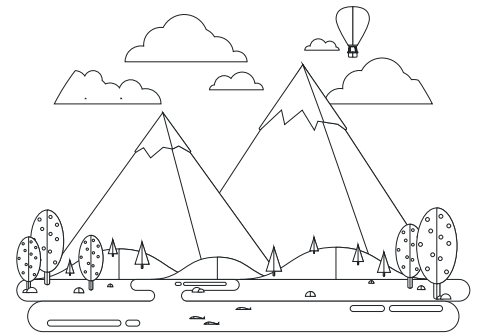
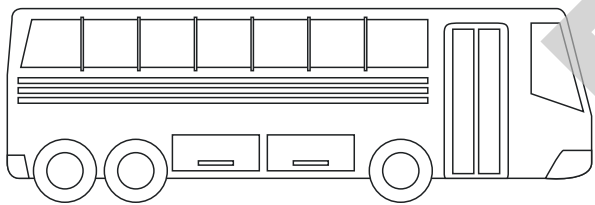
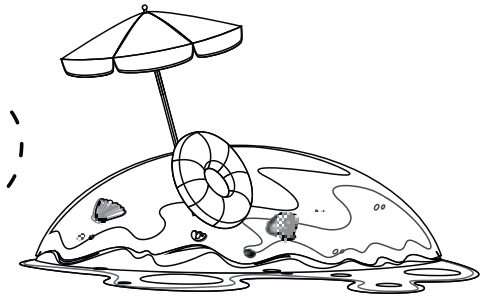
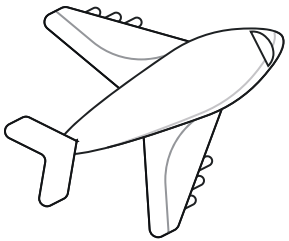
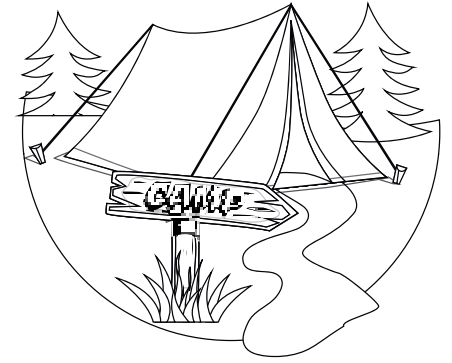
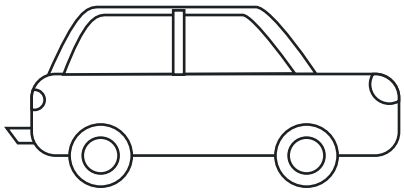

Lesson 23



Listen and circle.

1



2

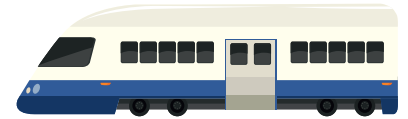

3

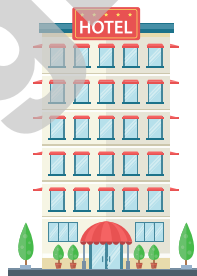

Lesson 24

Show What You
Know!



EnglishHouse



Listen, colour and play.

BINGO

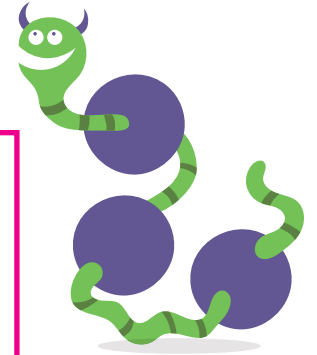

12	26	9
20	13	28
10	11	30



Lesson 25



Listen and colour.

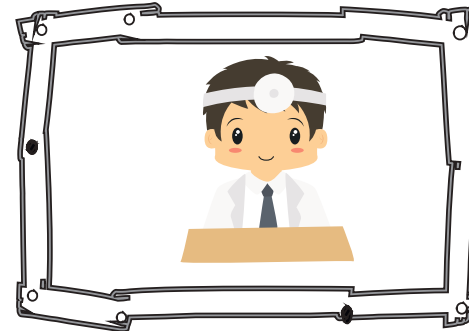
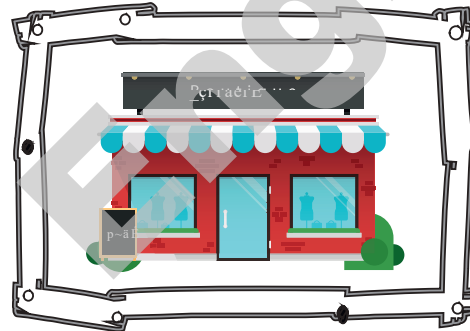
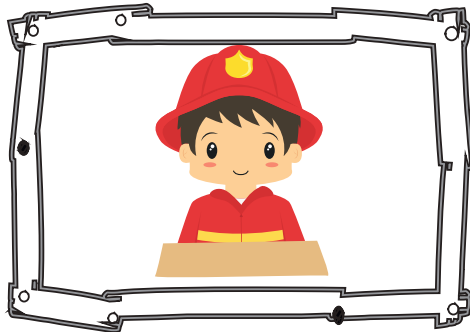
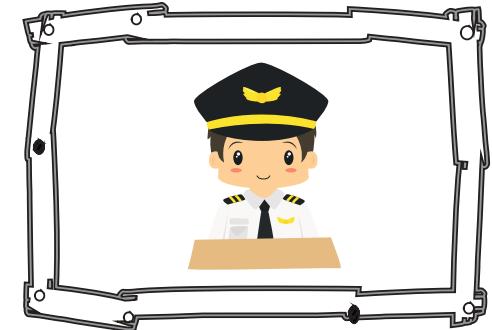
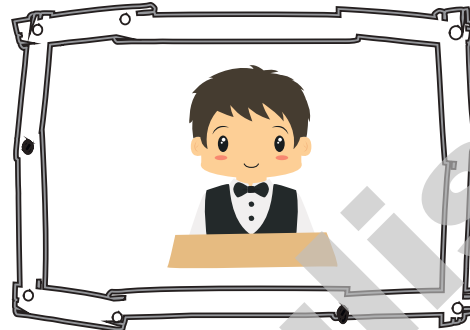
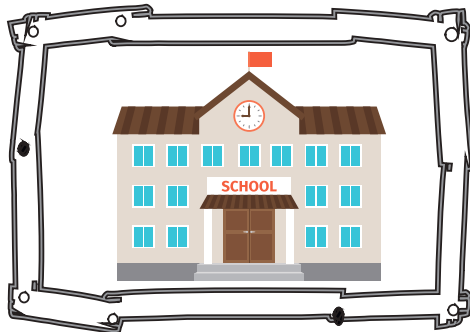
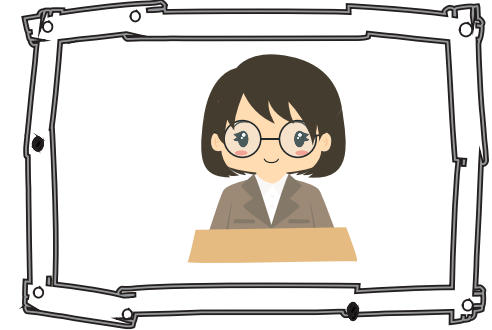

Lesson 26



Listen and colour.



yes

no



yes

no



yes

no



yes

no

Lesson 27

Unit 6

Fantastic Animals





Trace and colour.

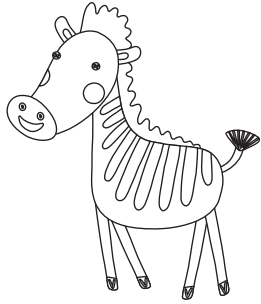

zebra

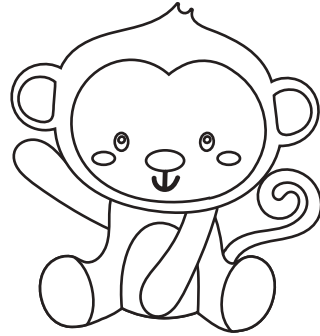

monkey

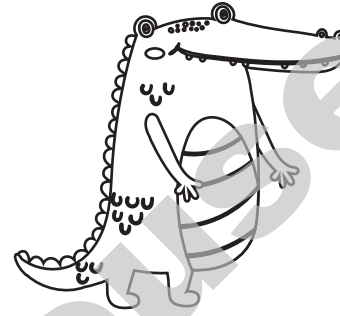

crocodile

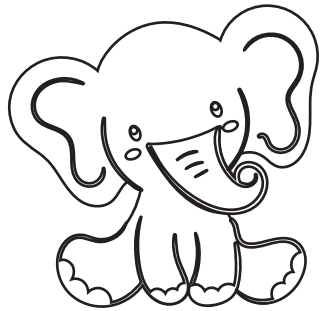

elephant



tiger

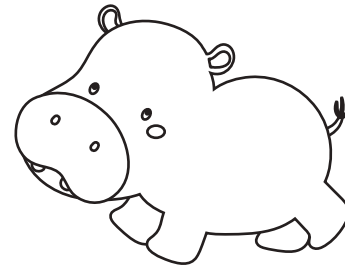

hippo

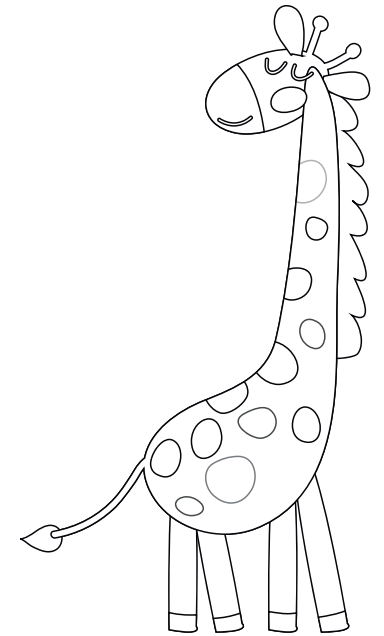

giraffe

Lesson 01



Look, tick and colour.



- lion
- tiger
- monkey
- snake
- zebra
- hippo
- crocodile
- giraffe

Lesson 02



Trace, read and match.

snake

hippo

tiger

zebra

monkey

crocodile

elephant

EnglishHouse

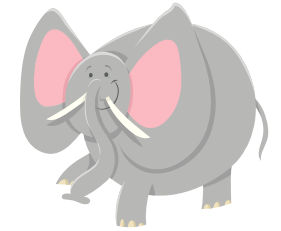

Lesson 03



Listen, look, colour and trace.

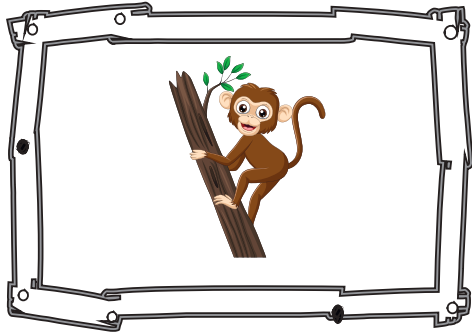

climbing

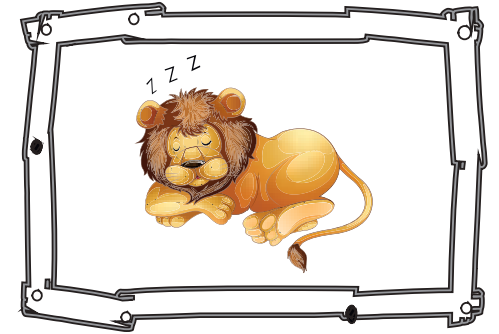

sleeping

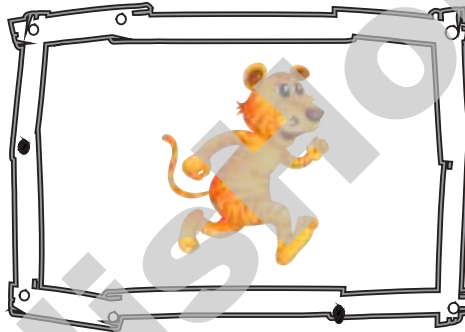

running



swimming

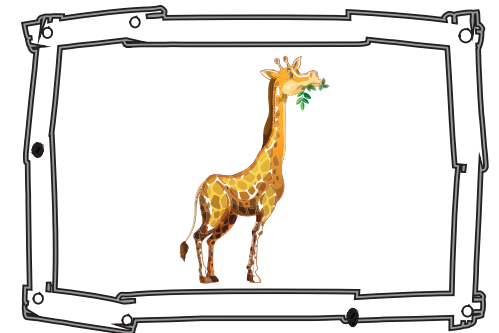

eating

Lesson 04

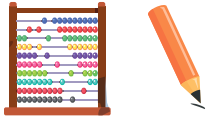

Count and write.

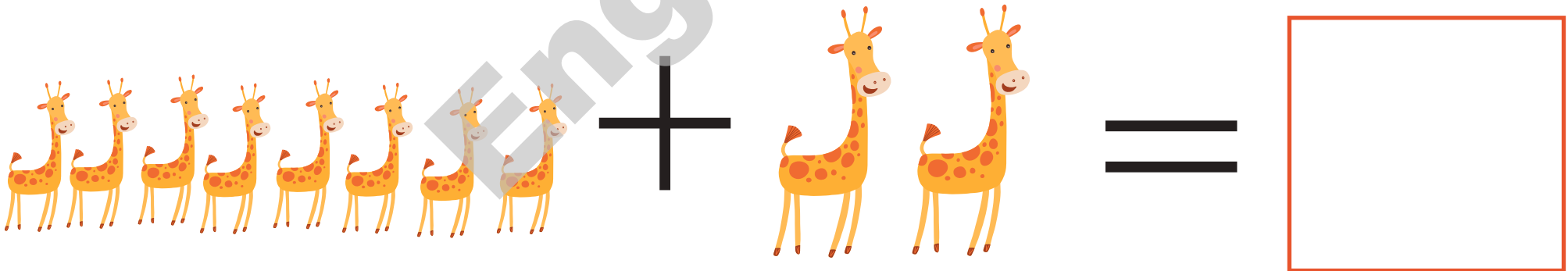
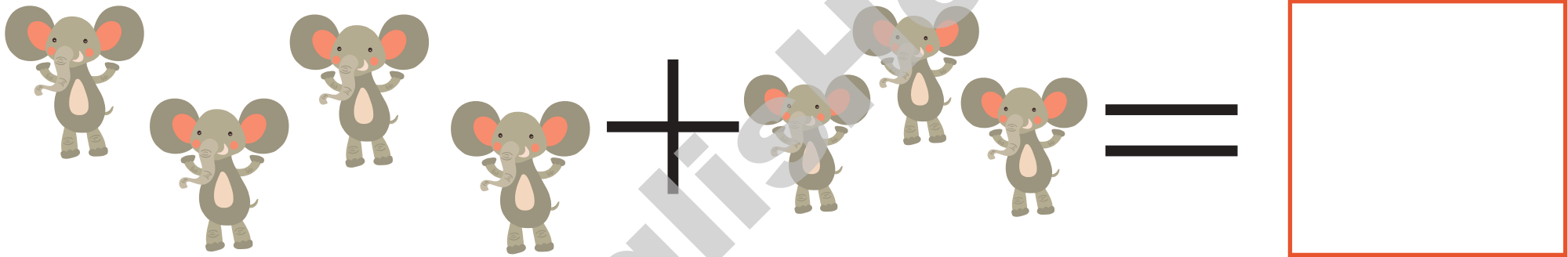

Lesson 05



Draw and colour.

My favourite animal.



Lesson 06

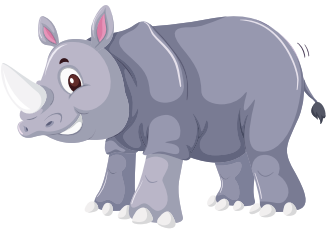
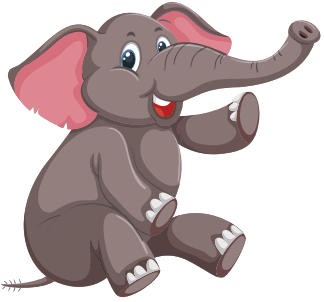
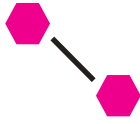

Match.

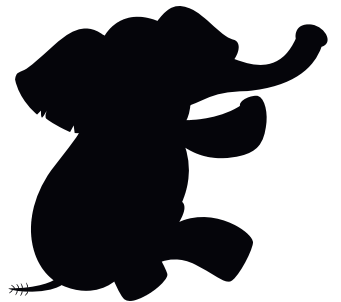
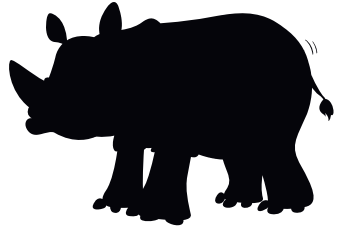

EnglishHouse

Lesson 07



Look and circle.

FIND
6
DIFFERENCES



Lesson 08

Count and play.

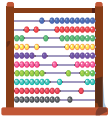

Lesson 09

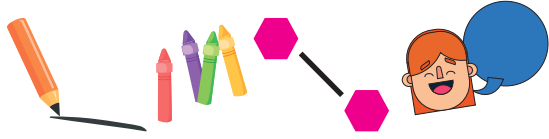

Trace, colour, match and say.

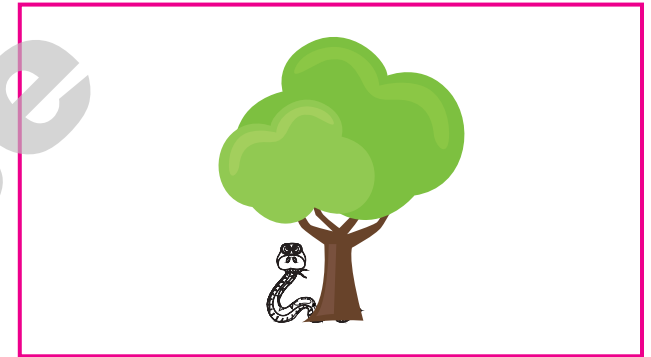
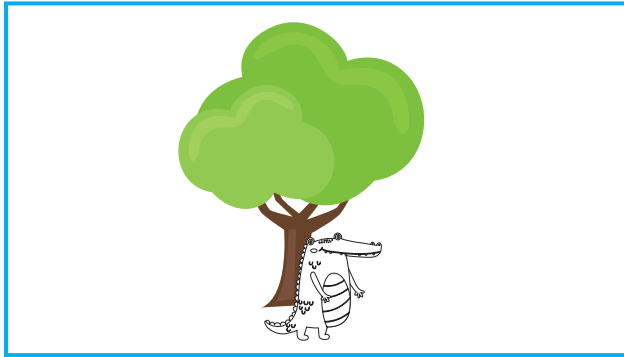

between

in front of

next to

behind

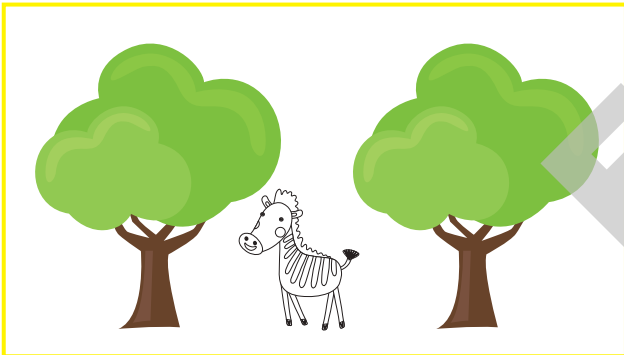

Lesson 10



Listen and draw.

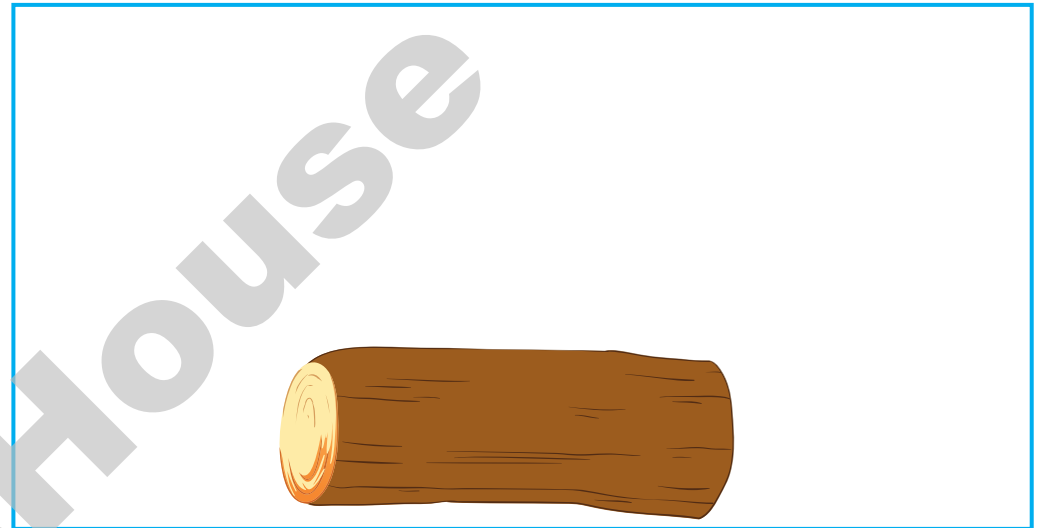
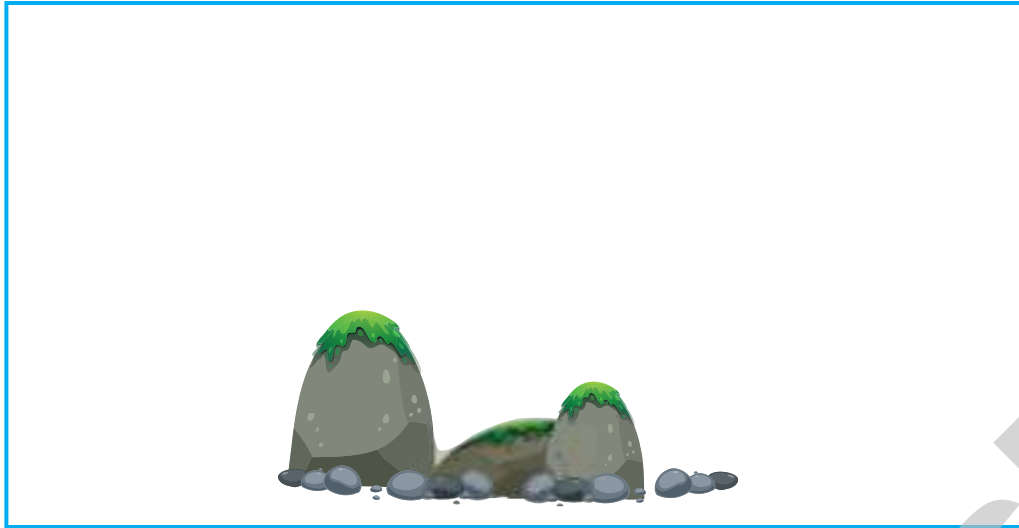

Lesson 11



Listen and colour.



Lesson 12



stripes

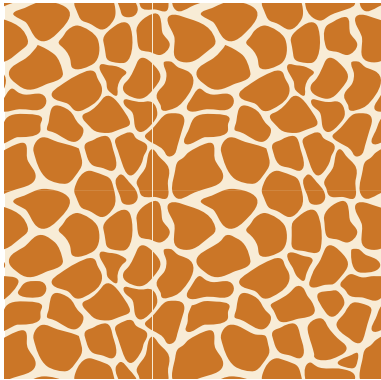

spots

Look, match, colour and trace.

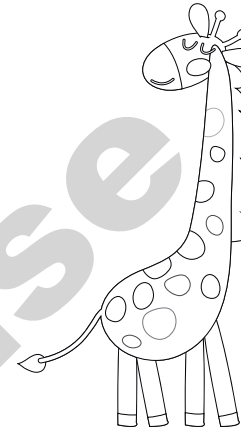

The giraffe has spots



The tiger has stripes

Lesson 13



spots

stripes

Colour, cut and paste.



Lesson 14



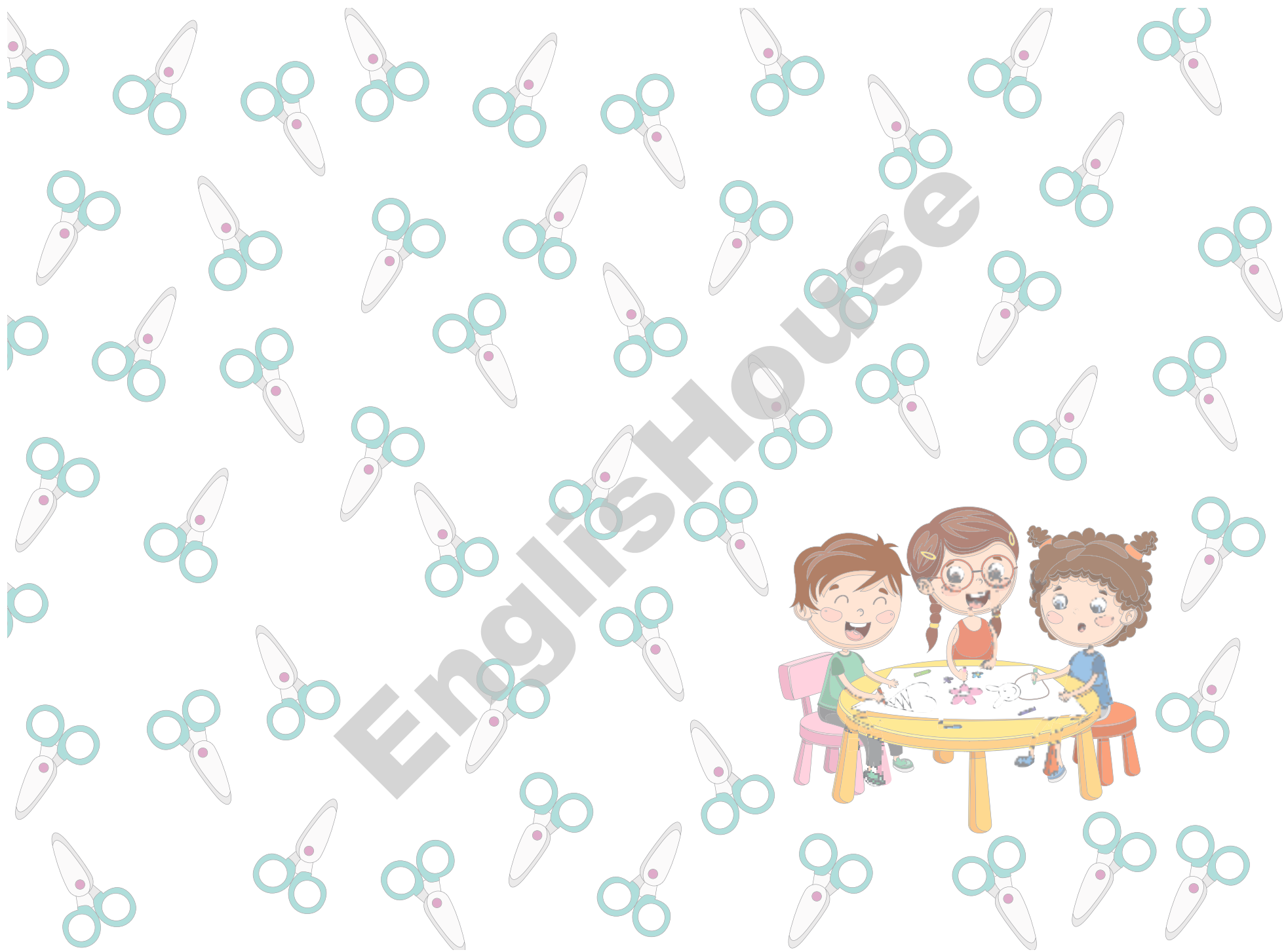

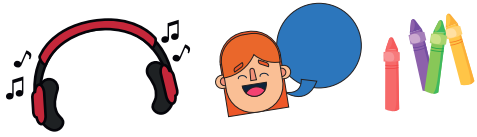
Listen, repeat and colour.

In the forest



deer



raccoon



fox



hedgehog



owl



rabbit



squirrel



Lesson 15



Listen, colour and trace.

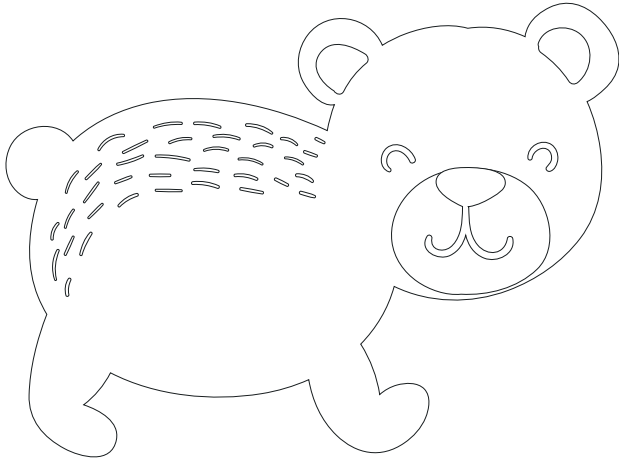

bear

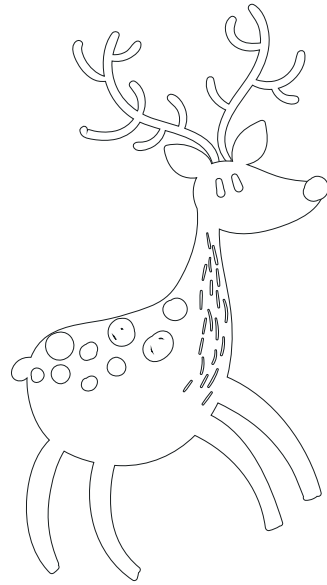

deer

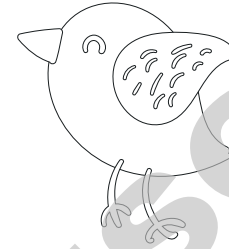

bird

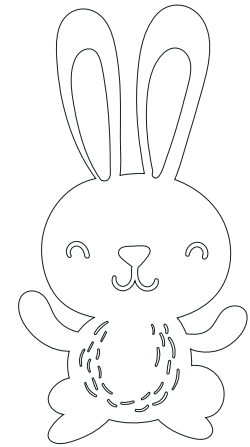

rabbit



owl

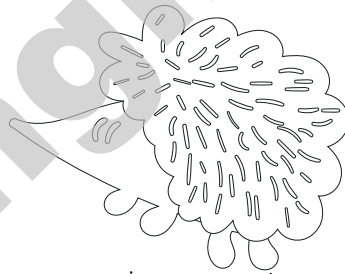

hedgehog

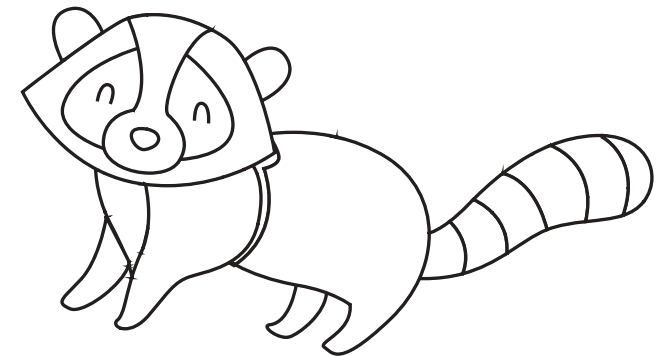

raccoon

Lesson 16



Colour, cut and play.

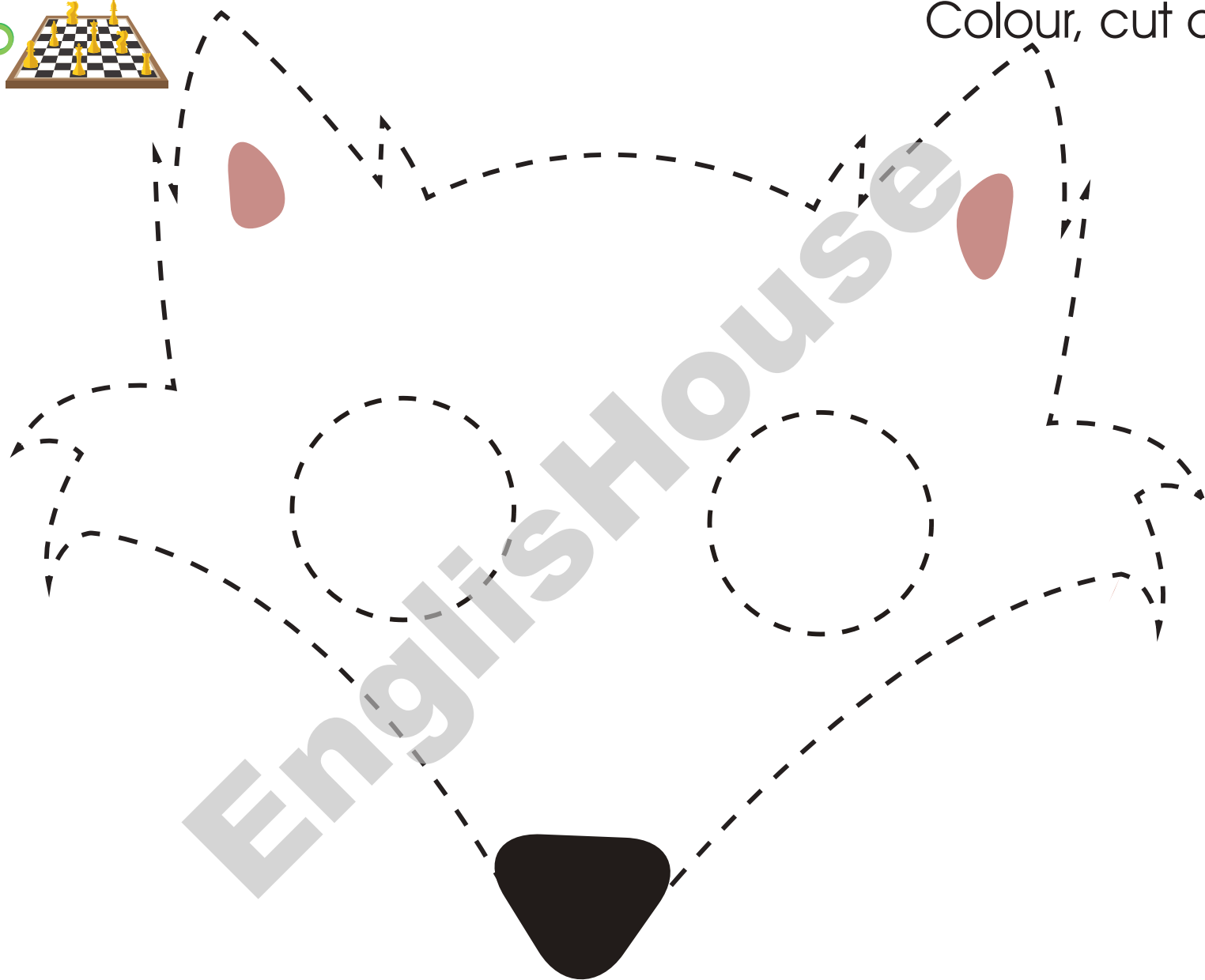

Lesson 17

EnglishHouse





Look, write and colour.

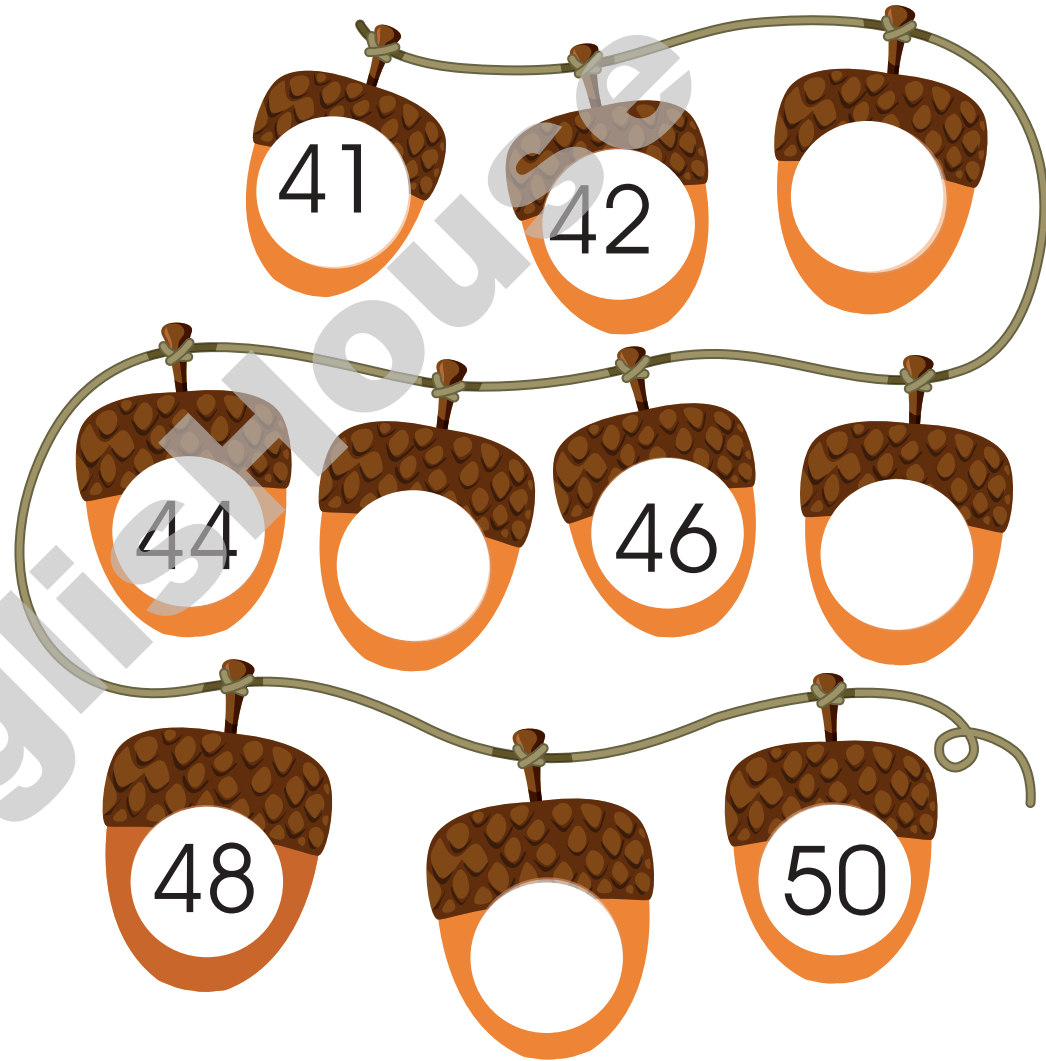

Lesson 18



Listen, circle and colour.

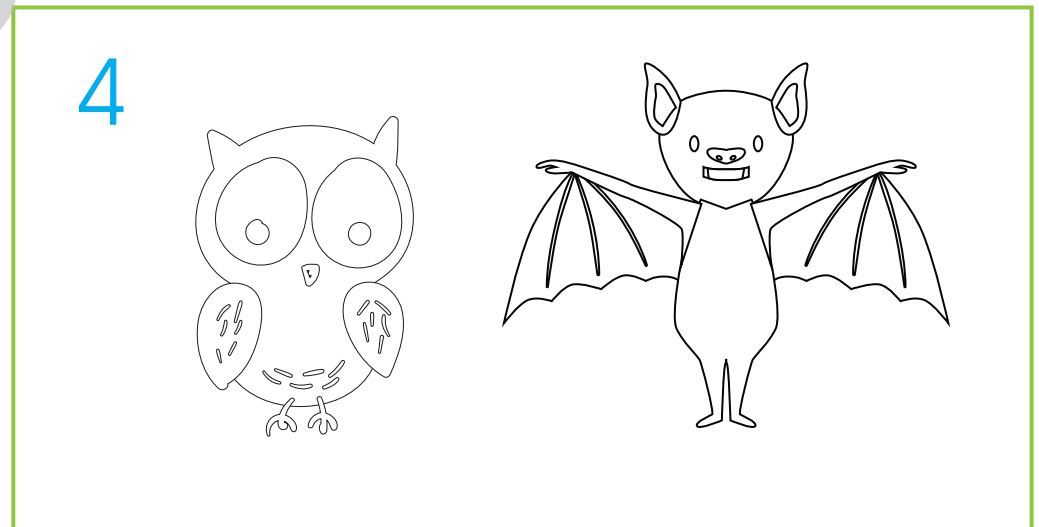
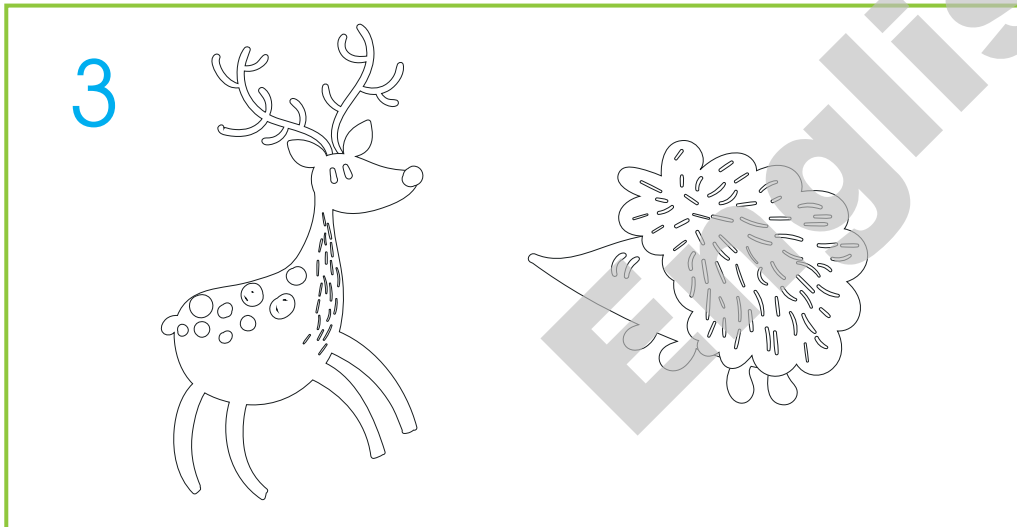
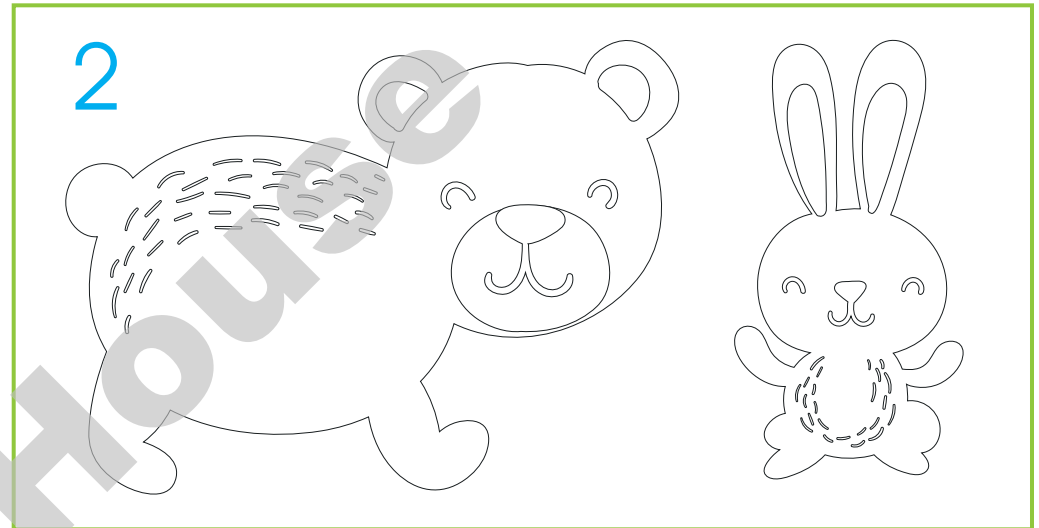
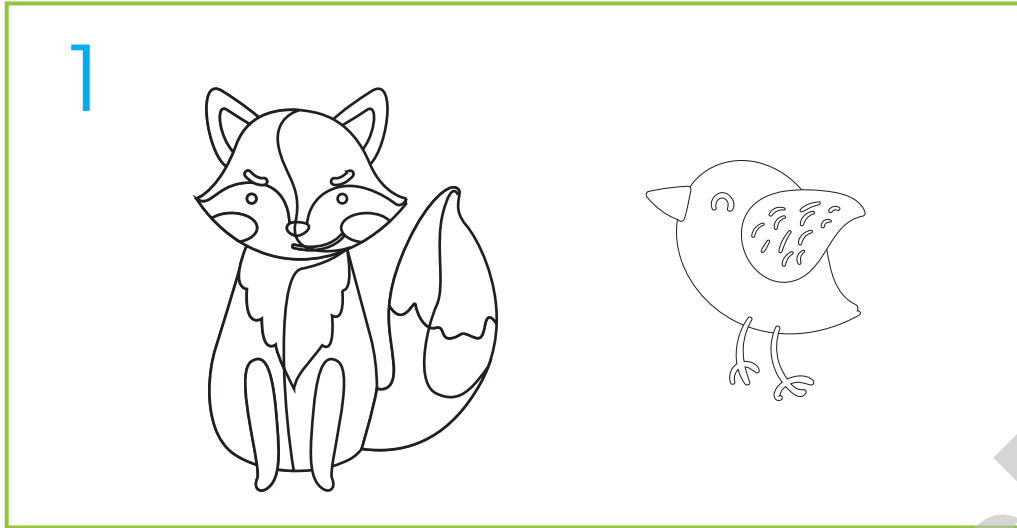

Lesson 19



Look, cut and paste.

Under the sea

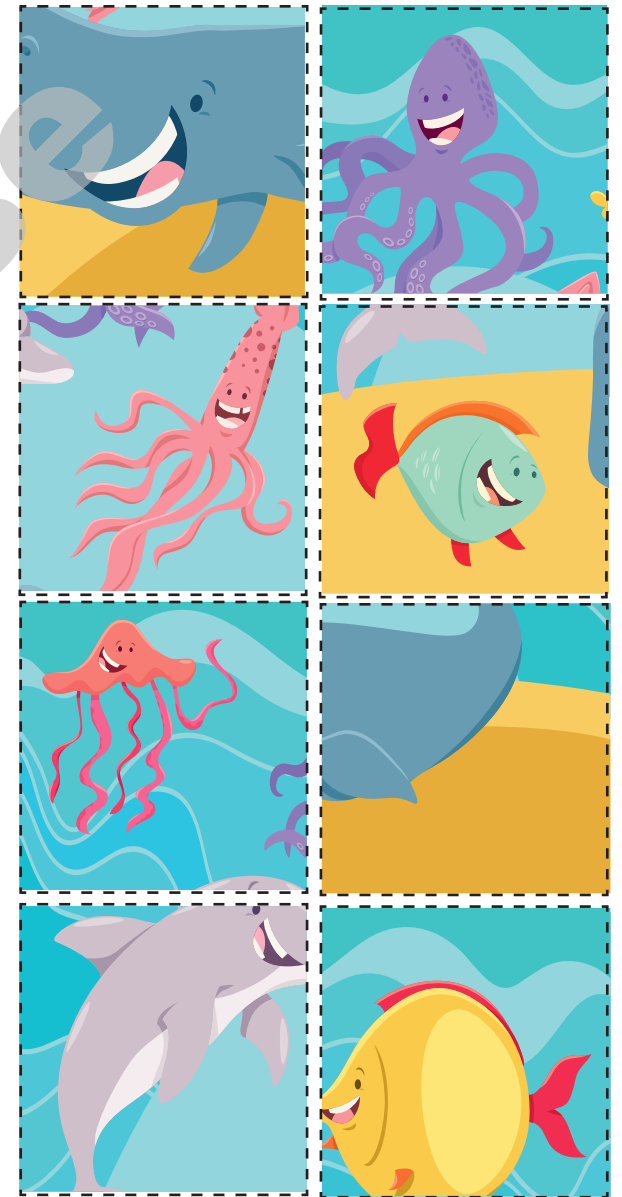

Lesson 20

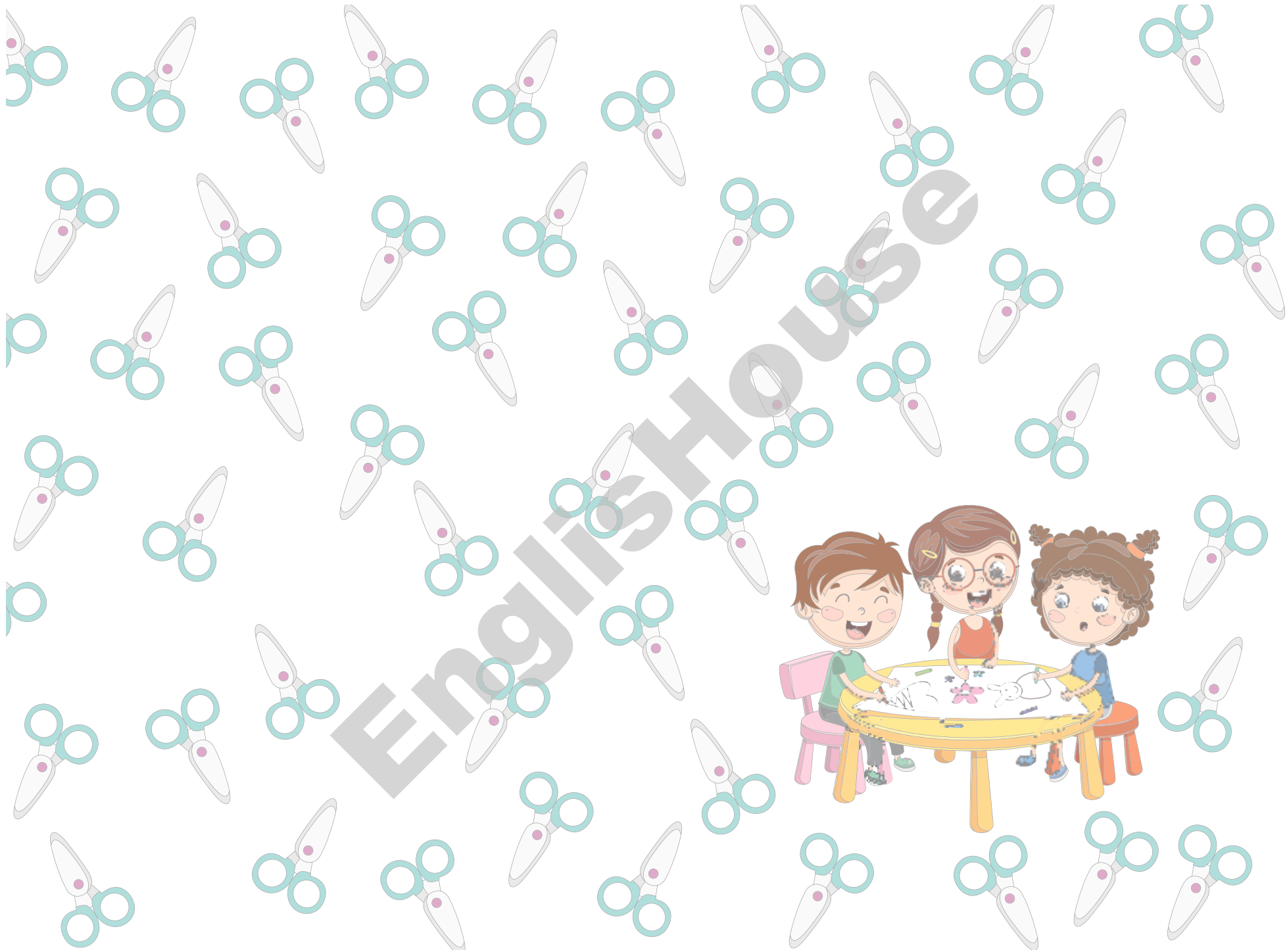



Listen and colour.



Lesson 21

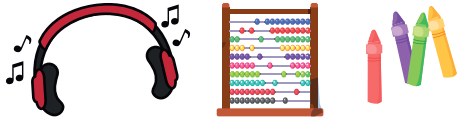

Listen, count and colour.

I can count to 100



Lesson 22



Colour, trace, cut, read and paste.

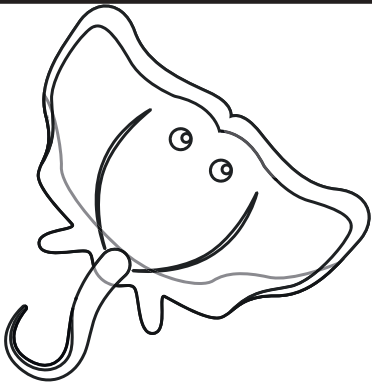
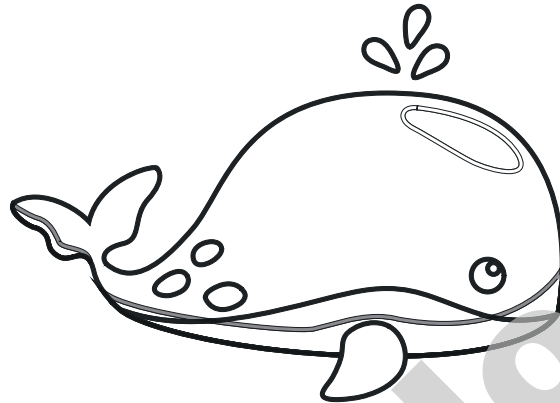
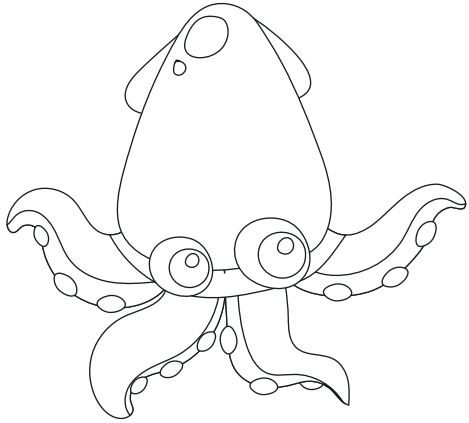

stingray

jellyfish

seahorse

whale



Lesson 23

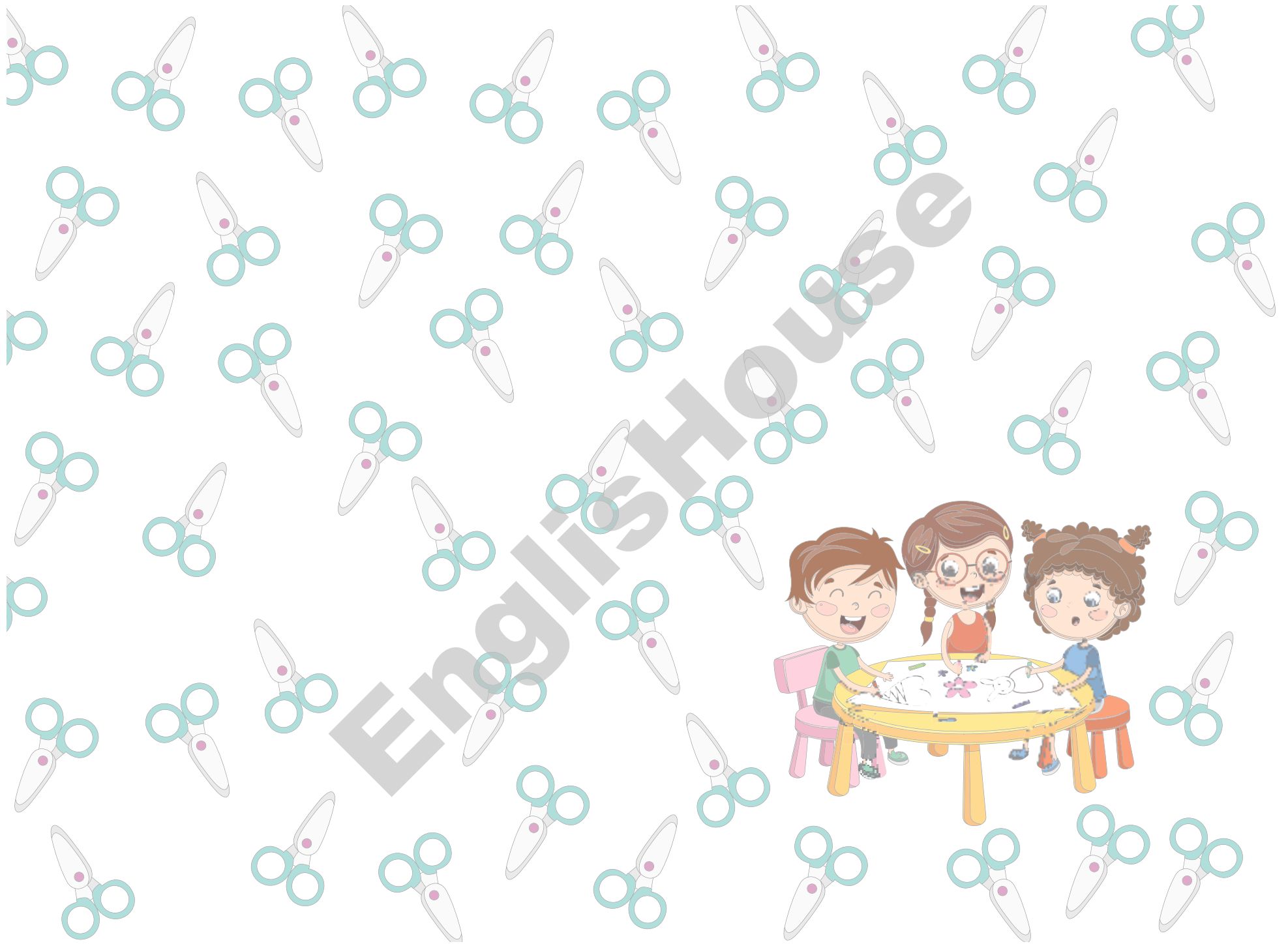



Listen, circle and colour.

1

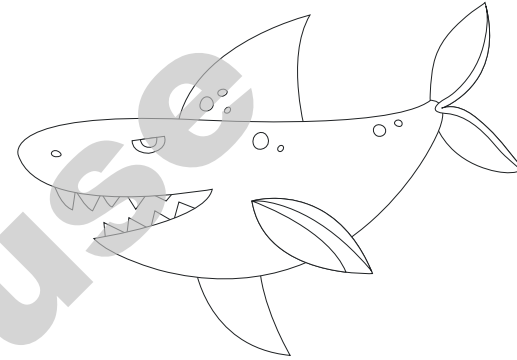
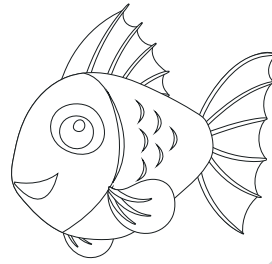
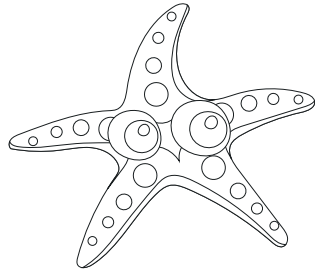

2

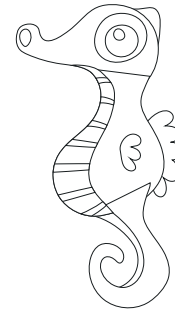
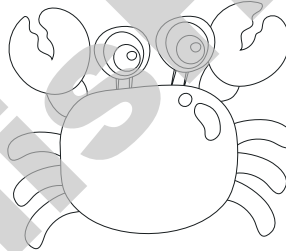

3

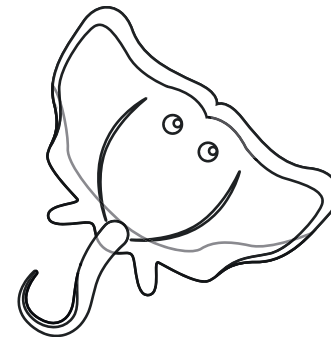
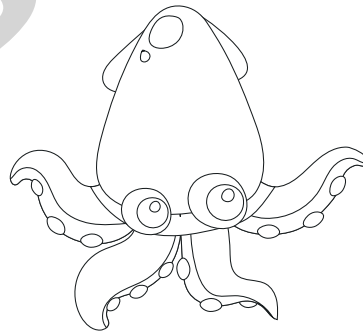
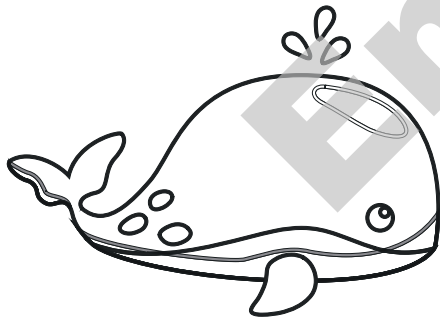

Lesson 24

Show What You
Know!

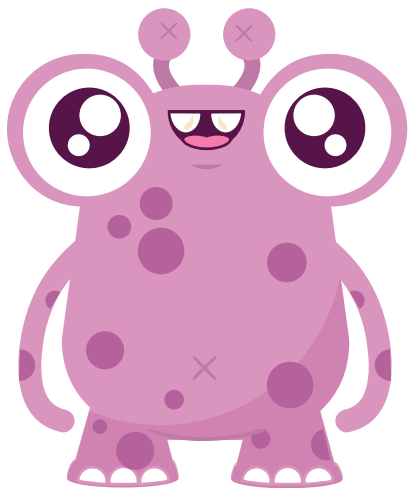



Colour, cut and paste.

jungle

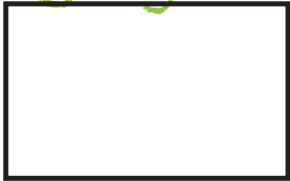

forest



sea

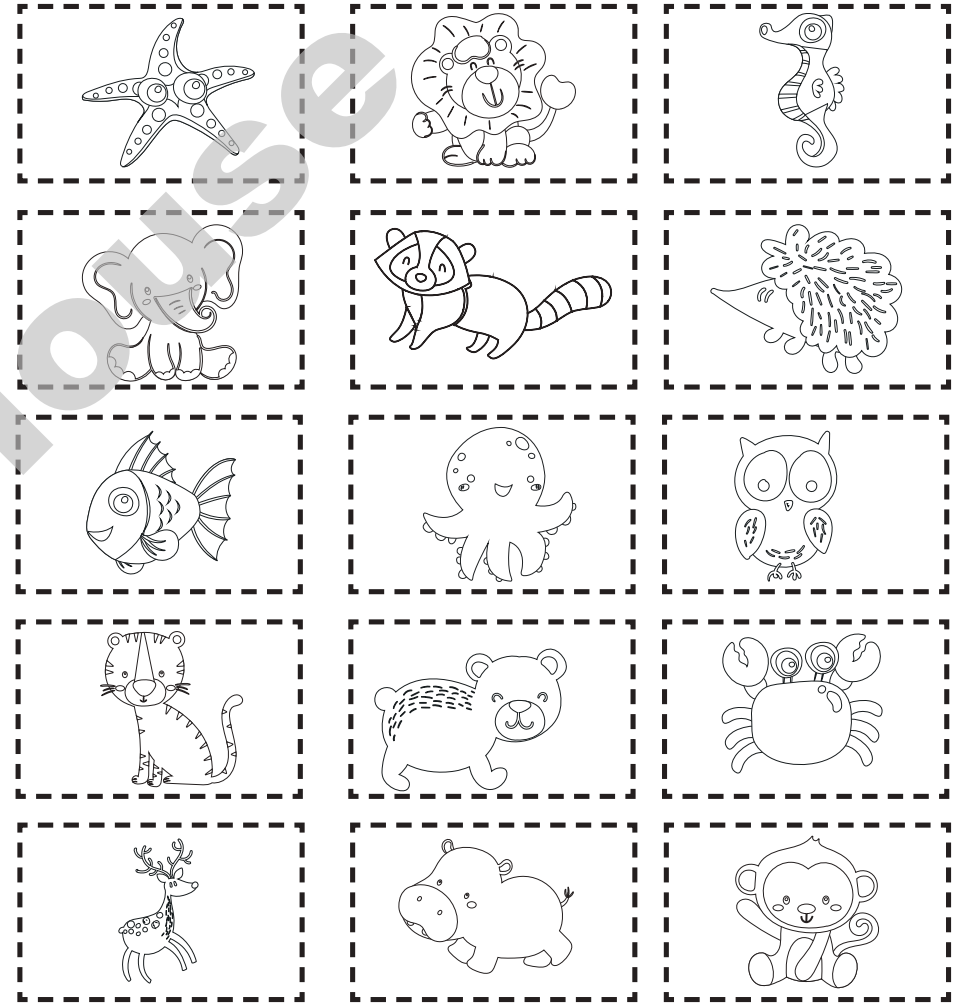

Lesson 25

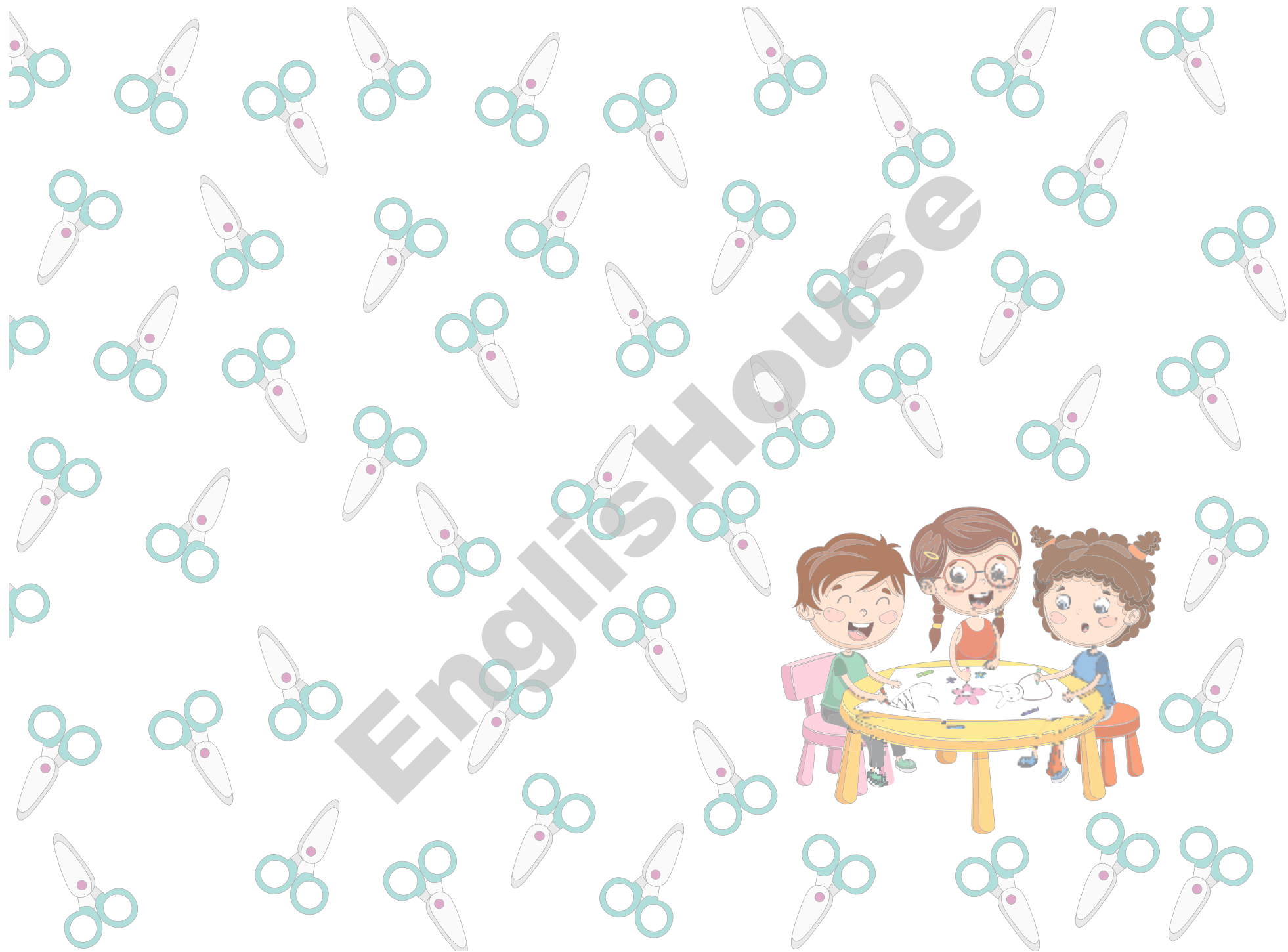



Read, draw and colour.

This animal can fly

This animal can swim

This animal can climb

This animal can run

Lesson 26



1, 2...

Listen and number.

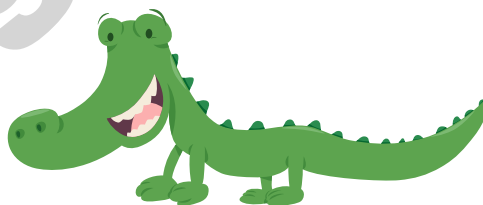
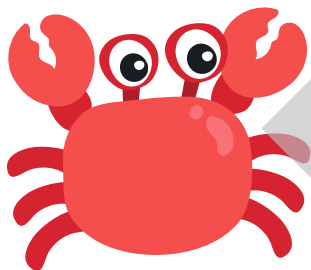
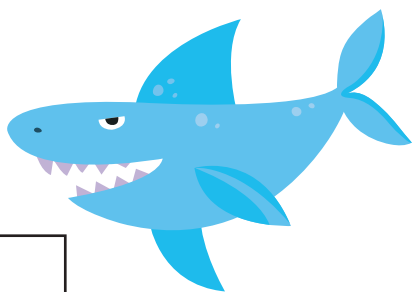

Lesson 27

Holidays

EnglishHouse

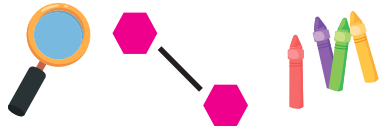

Look, match and colour.

ghost mummy scarecrow vampire zombie Frankenstein

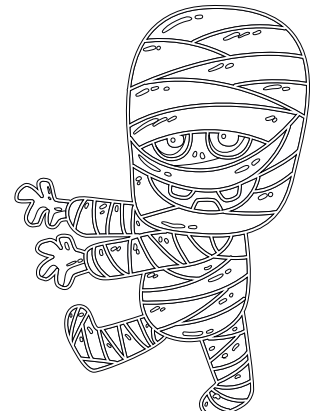
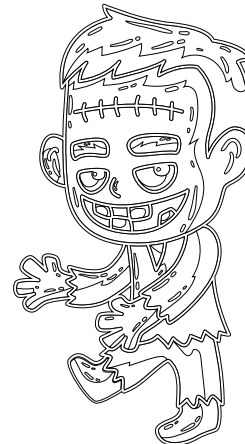
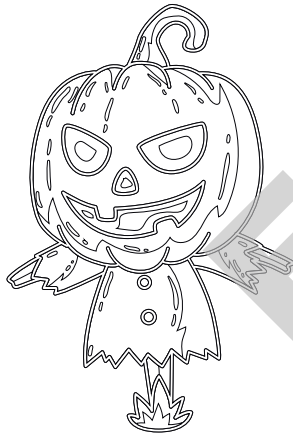
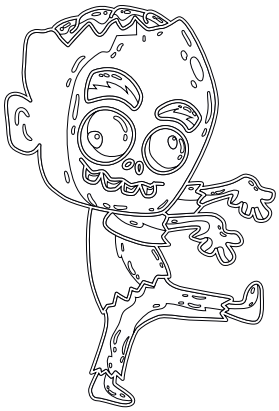

Halloween

Count and match.

- 1
- 2
- 3
- 4
- 5
- 6
- 7
- 8
- 9
- 10

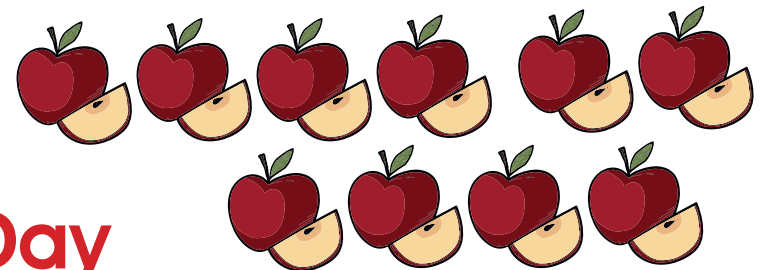
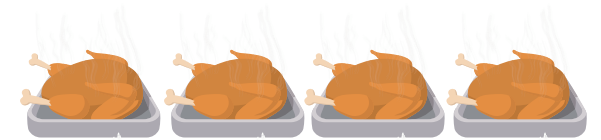
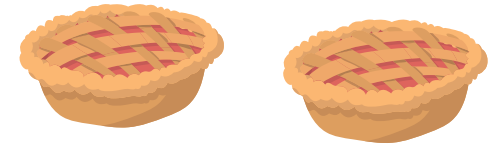

Thanksgiving Day

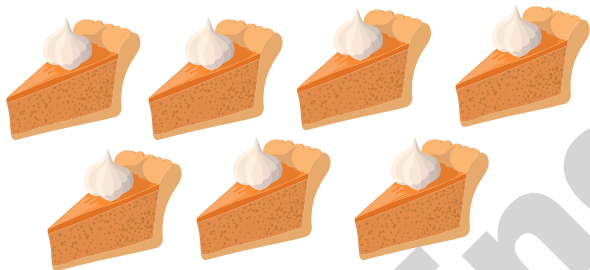
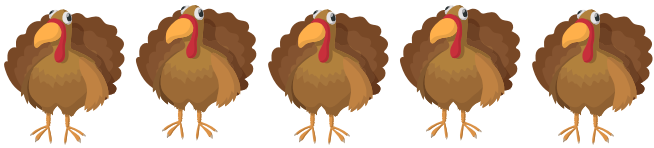
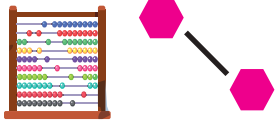



Colour and write.

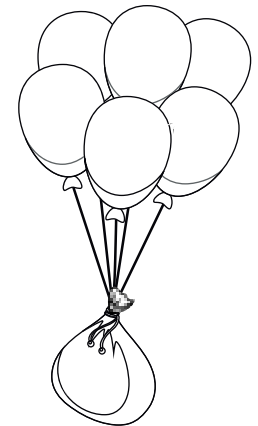
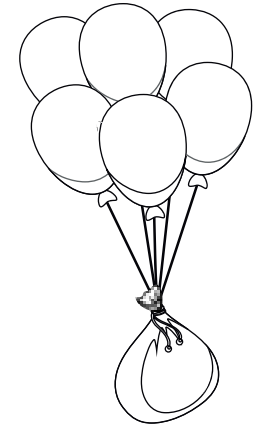
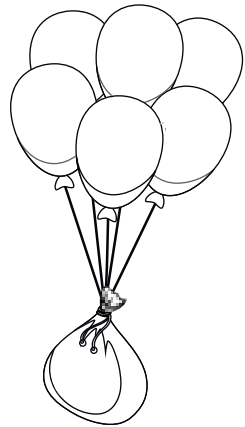
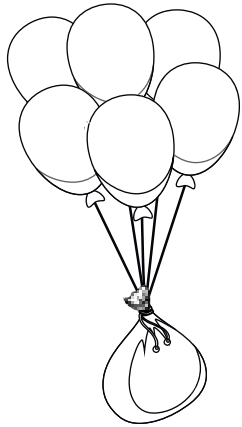

Christmas

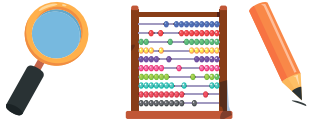

Look, count and write.

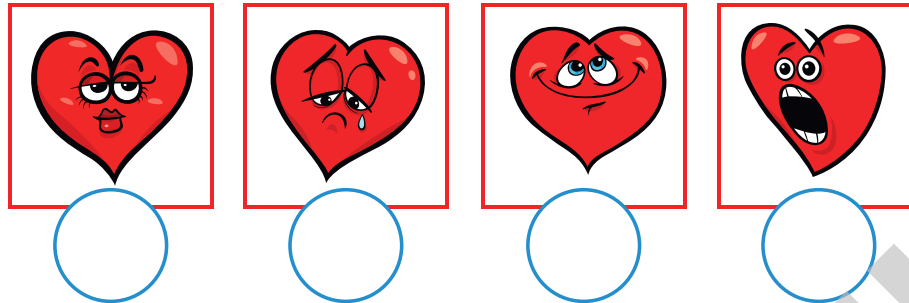

HOW MANY?

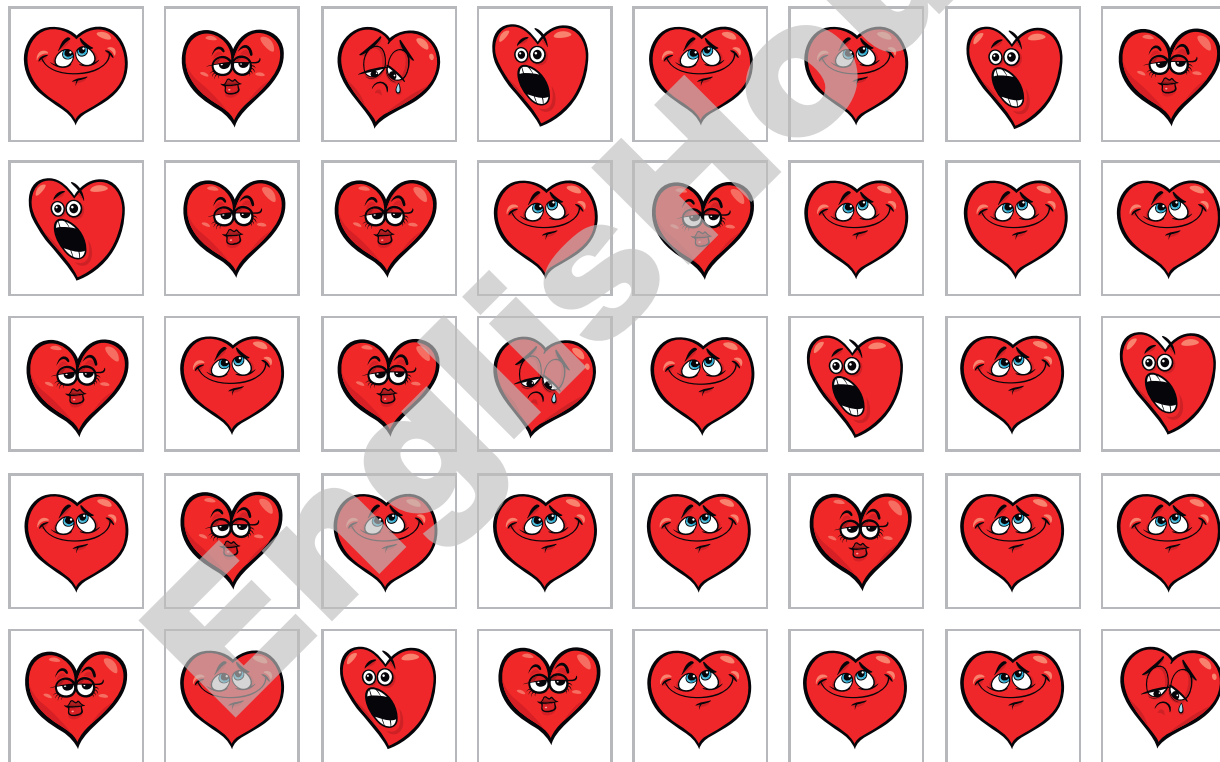

Valentine's Day



Listen and colour.

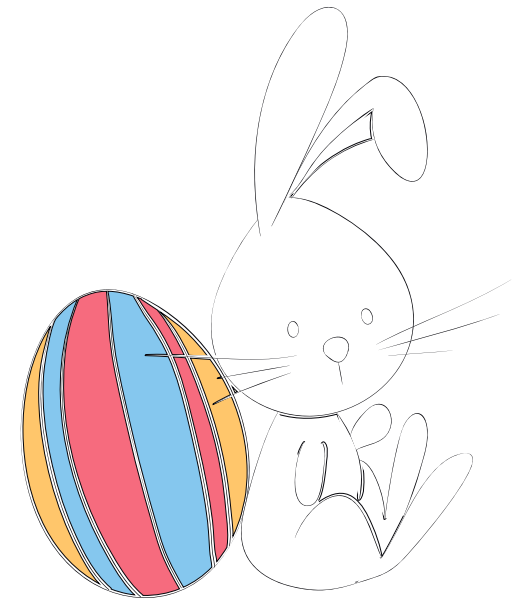
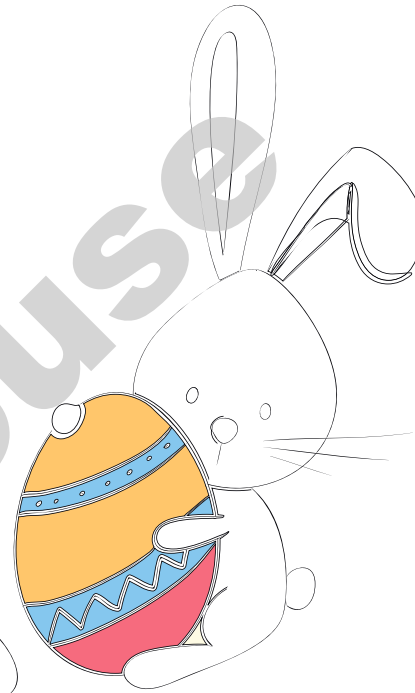
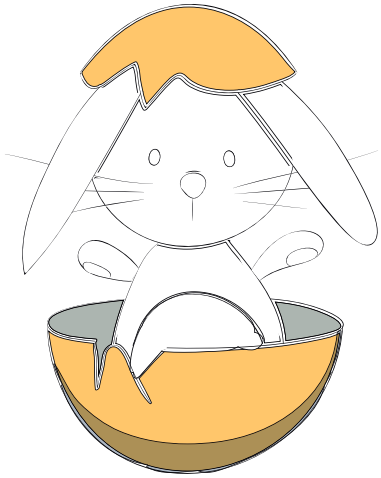
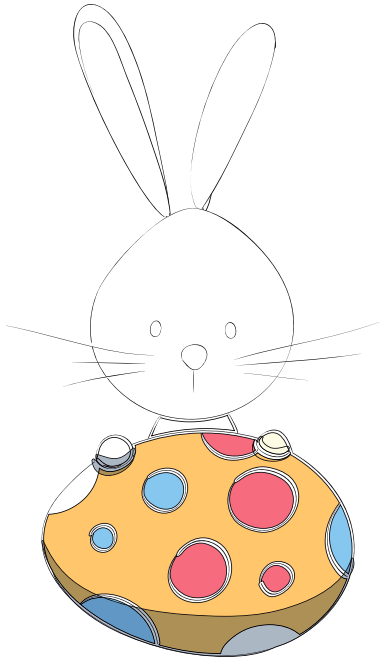

Easter



Decorate, cut and assemble.

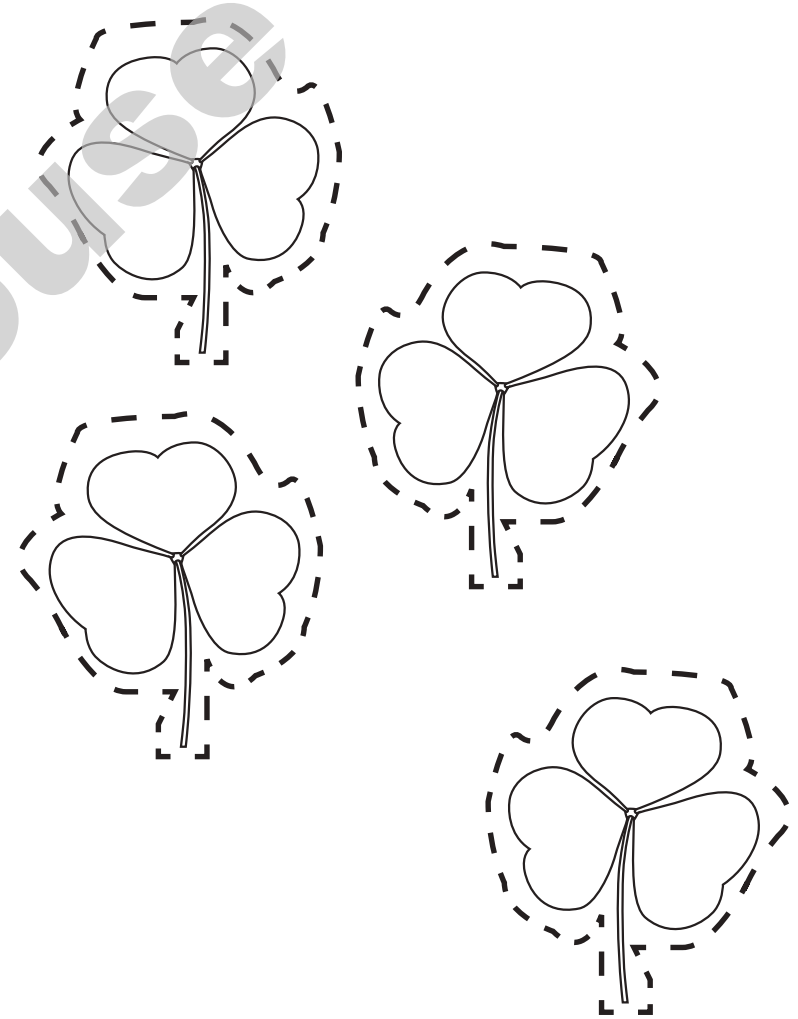
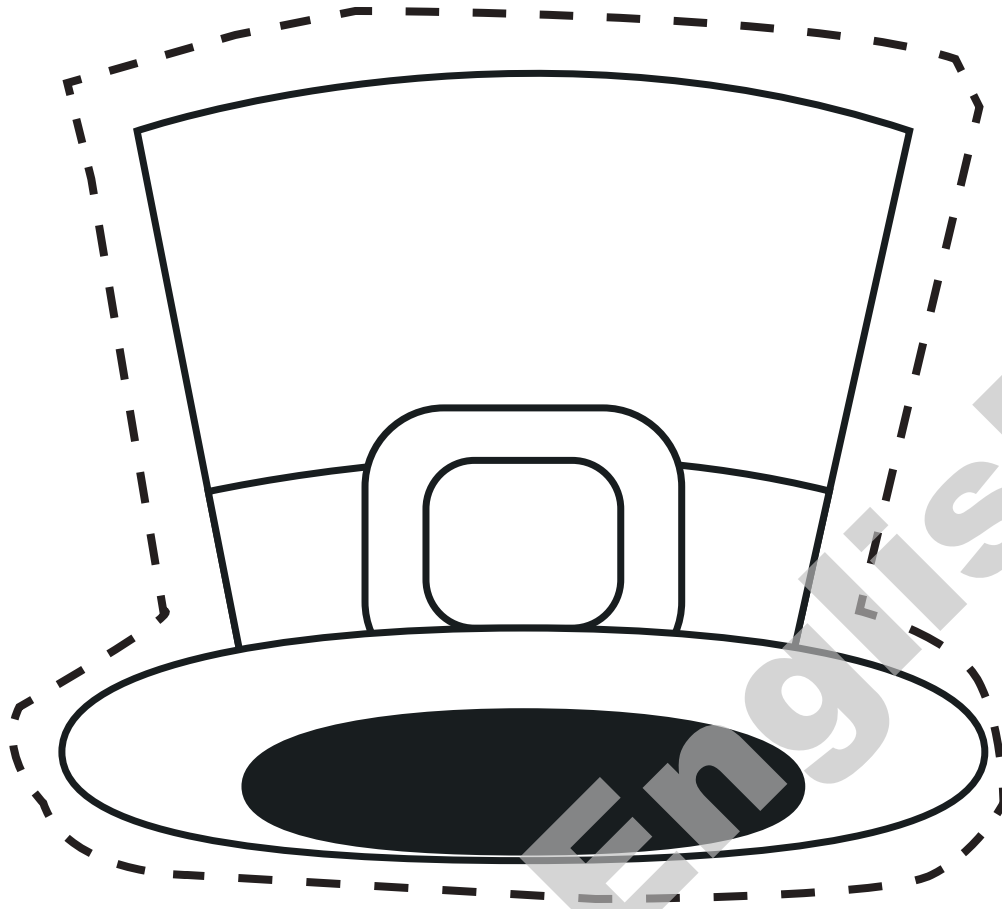

St. Patrick's Day

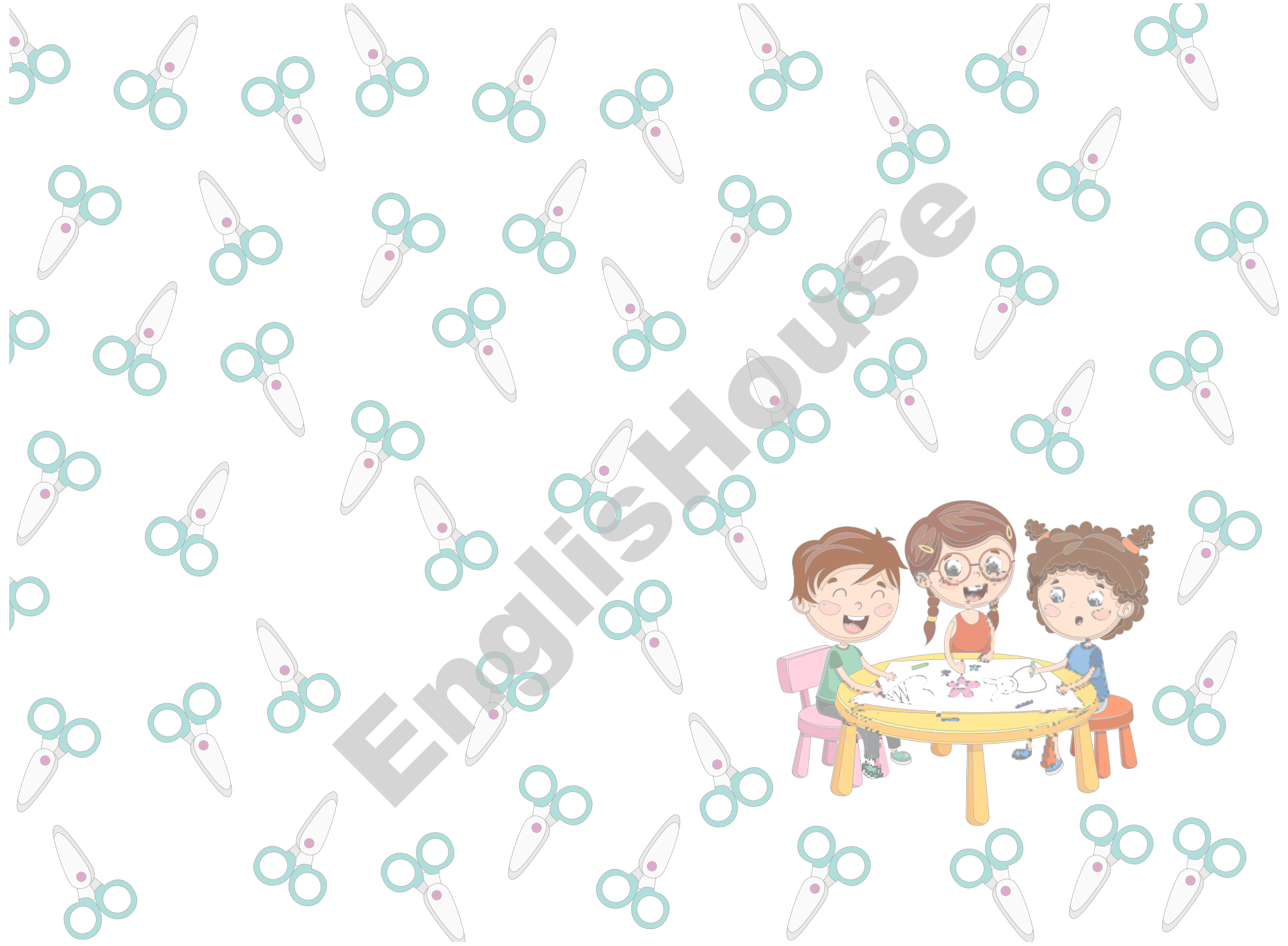

EnglishHouse





Colour, write and cut.

HAPPY
Mother's
DAY

Mother's Day

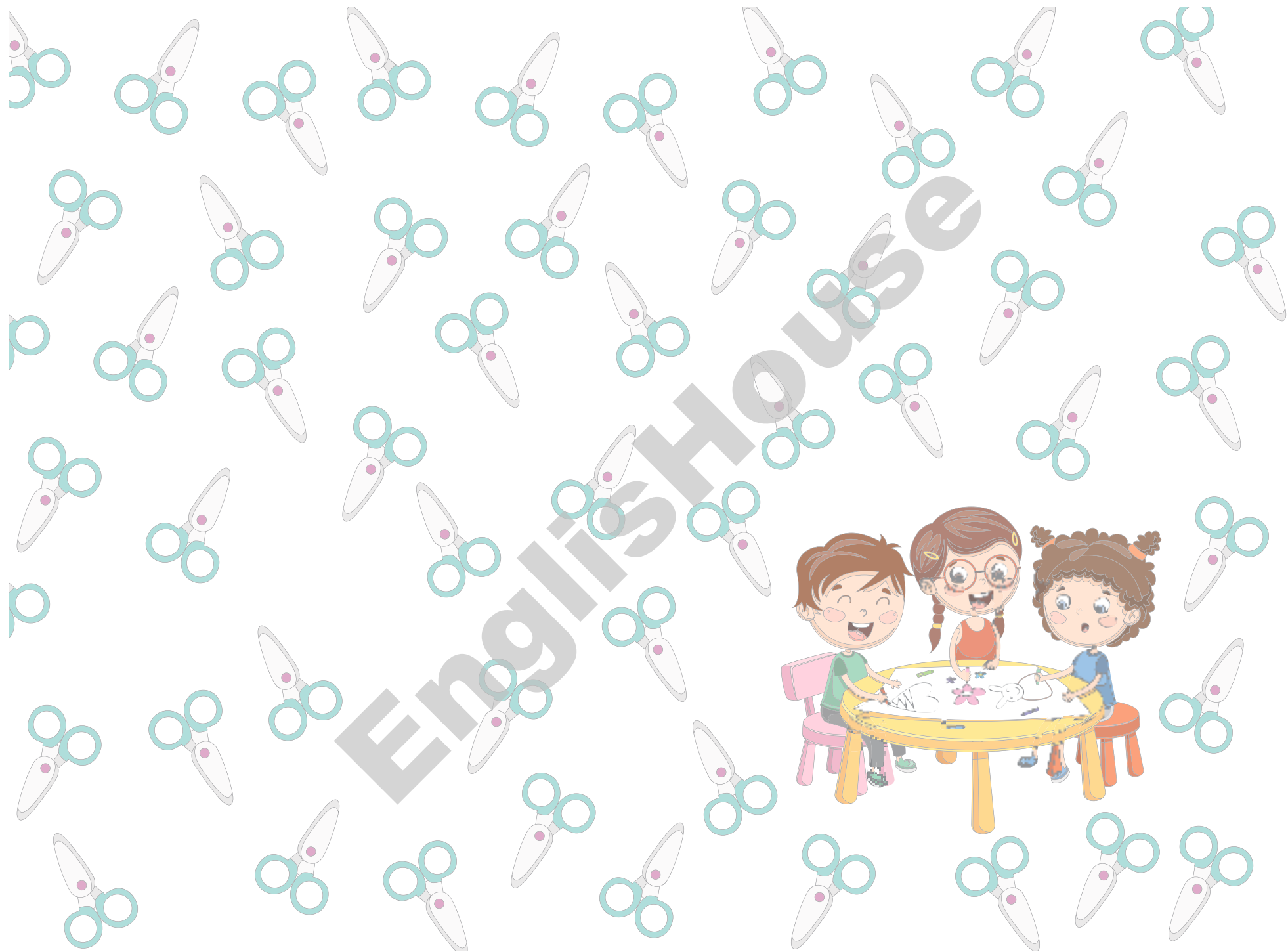



Decorate, cut and assemble.

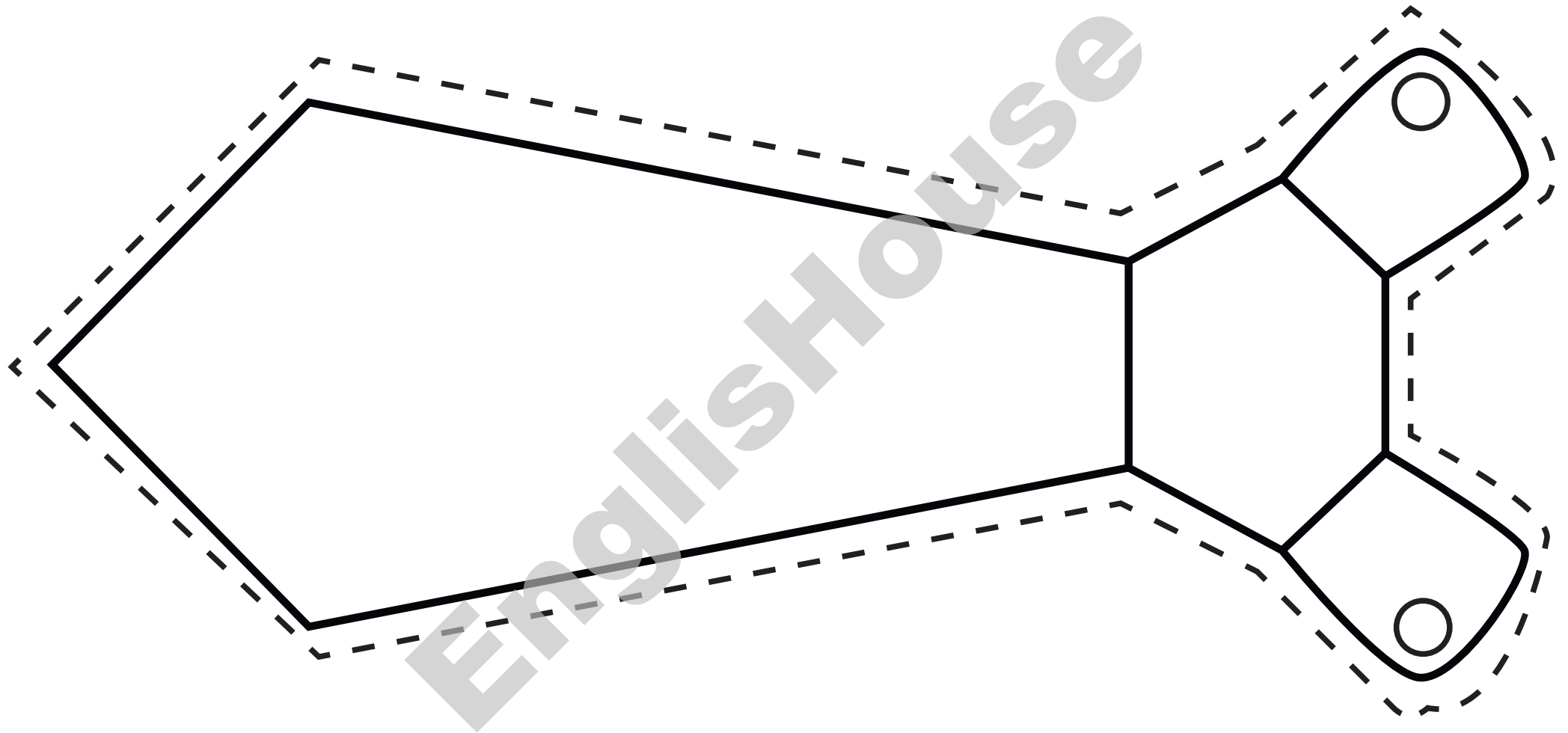

Father's Day

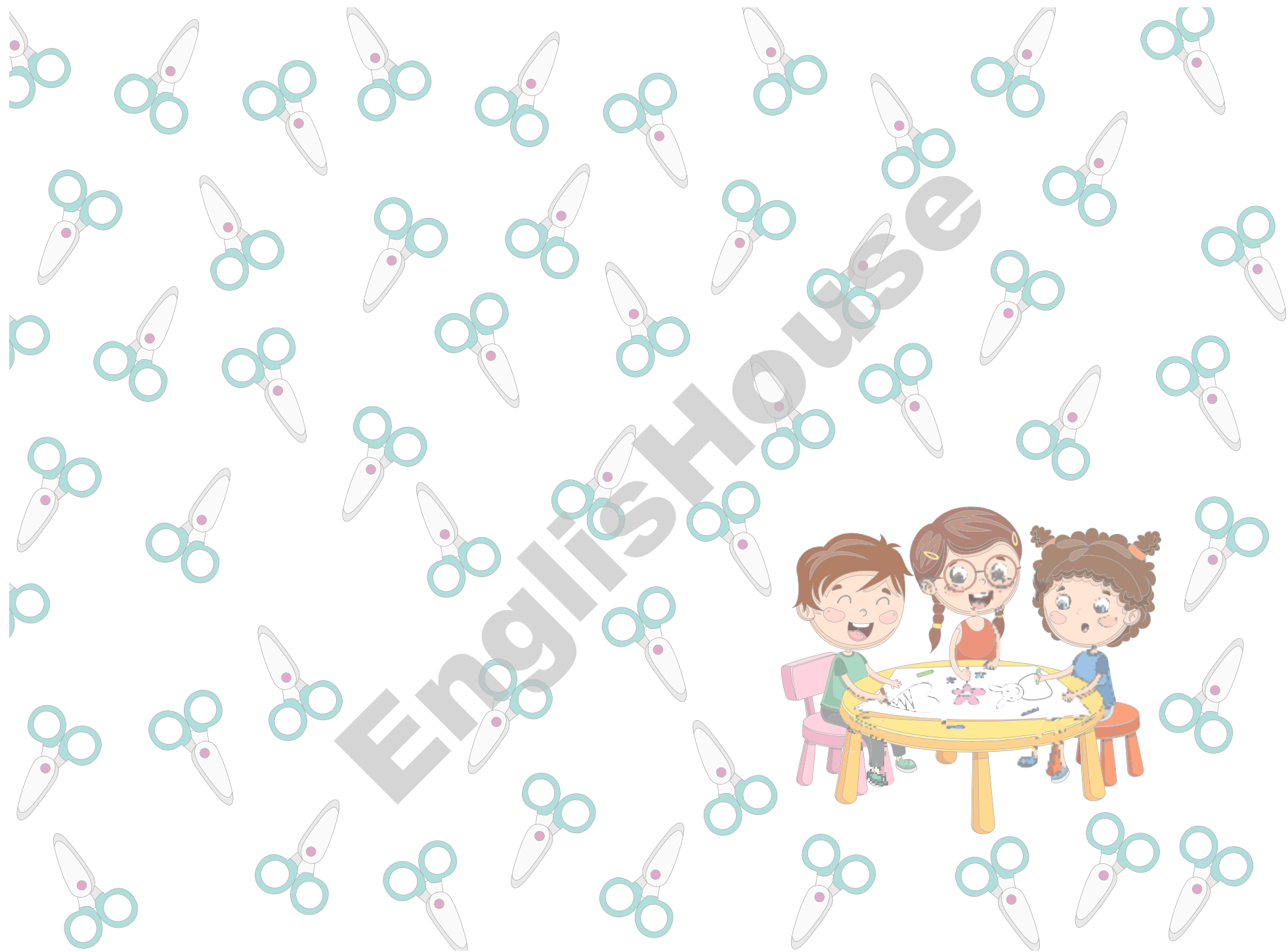

EnglishHouse

